



TE'S CROMPTON INSTRUMENTS ANALOG METERS

Table of contents

I. DIN panel meters



An extensive range of 48, 72, 96 and 144 mm DIN style panel meters. Short-scale ammeters, voltmeters and frequency meters incorporate slide-in dials and terminal covers. Long-scale meters are also available. Meters for power or energy contain in-built transducers and can be customized to suit many different system configurations and ranges. UL, CSA and Marine Approved.

6



Chapter 1

II. Saxon series panel meters



A range of 2 1/2", 3 1/2" and 4 1/2" surface mount panel meters utilising pivot and jewel mechanisms and offering IP54 protection. The range offers iron vane and moving coil AC and DC ammeters and voltmeters, elapsed time and frequency meters. UL and CSA Approved.

36



Chapter 2

III. Fiesta series panel meters



A robust range of short-scale 3 1/2" surface mount panel meter offering IP55 protection and featuring wide-view contoured windows. The range offers iron vane and moving coil AC and DC ammeters and voltmeters, elapsed time and frequency meters. UL and CSA Approved.

42



Chapter 3

IV. Challenger series panel meters



A range of 1 1/2", 2 1/2", 3 1/2" and 4 1/2" analog panel meters. The Challenger analog panel meters feature a detachable lower fascia plate, which allows either surface or window mounting. Meters use a high torque pivot and jewel movement. UL and CSA Approved.

48



Chapter 4

V. ANSI switchboard meters



High quality range of switchboard instruments with Class 1 accuracy and which complies with American ANSI-C39.1 (1981) specifications. Available in 4 1/2" case size, the rugged design characteristics meet the needs of the most demanding environmental applications.

56



VI. Meter relay panel meters



Series 239 meter relays combine a highly accurate indicator with High and Low set point relays. The relays can operate alarm and control devices when the monitored signal value moves outside the chosen set point limits shown by adjustable red index pointers.

80

VII. Sealed and ruggedized panel meters



Designed to comply with industrial, marine and military specifications, these 240° and 90° scale meters are resistant to extreme shock, vibration, temperature, dirt and humidity. The range offers a wide range of bezel sizes fitted with toughened glass.

86

VIII. Instrument selector switches



Panel mounted selector switches offer a 7-position voltmeter switch and a 4-position ammeter switch for reading line-to-line or line-to-neutral voltage and phase current.

92

Should you need more details about product codes, please check the product builder sheets on the website www.crompton-instruments.com/analog.html





Chapter I

DIN panel meters

Short scale.....	6
Long scale.....	14
Dual voltmeter and frequency meter.....	20
Phase sequence indicators and phase angle meters.....	21
Power factor meters.....	22
LED synchroscope.....	23
Synchroscope.....	24
Power wattmeters.....	25
Power.....	26
Long scale tap position indicators.....	32

DIN panel meters – short scale

FEATURES

- A range of the most popular short-scale measuring instruments in 4 case sizes
- Shock resistant sprung pivot and jewel movement
- Terminal covers supplied as standard
- EMC hard frequency meters are fully EMC and LVD compliant
- 1/4" 'fast on' terminals available



APPLICATIONS

- Switchgear
- Distribution systems
- Generator sets
- Control panels
- Energy management
- Building management
- Utility power monitoring
- Process control
- Motor control

APPROVALS



BENEFITS

- Low cost
- Local indication
- Ease of installation
- Minimal training
- Low maintenance
- Customized options and features

A range of 48, 72, 96 and 144 mm DIN style panel meters measuring all electrical parameters and featuring moving coil or moving iron movements. All meters incorporate slide-in dials and terminal covers as standard. A range of customized options is available.

MOVEMENTS

MOVING COIL METER

Centre cored, self shielding moving coil movement, using pivots, hairsprings and sprung jewels. Seven variations have been designed in movement ranges: all intermediate ranges are achieved by shunting the next lowest range. All DC voltmeters are 1000 ohms per volt, rectified product run at 900 ohms per volt, millivolt meters use the 5 milliamp movement.

MOVING IRON METER

Clapper type repulsion design using pivots, hairsprings and jewel movements. The bottom jewel is oil filled to provide damping while the top is sprung for resilience. All voltmeters are manufactured with external voltage dropper resistors to substantially reduce the self heating effects.

FREQUENCY METER

Meter uses a 100 microamp 4000 ohm movement driven by an EMC hard frequency conversion circuit.

DIALS, SCALES AND POINTERS

Standard dials are white matt with black printed scales and bar knife-edge pointers. Black dials with white or yellow scales and pointers are also available. Interchangeable slide-in dials are used on the E242, E243, E244 and E246 90° moving iron, moving coil and frequency meter models.

General options include red supplementary pointers, red indexes (quadrant scales), red, green or blue lines, bands or segments, finely spaced divisions, multi-scales, special scales and captions to customer's requirements.

SPECIFICATIONS

Type of instrument	Moving iron for current and voltage	Moving coil for current and voltage	Moving coil with rectifiers for current and voltage	Moving coil with built-in transducer for frequency measurement	Maximum demand indicators	Combined MD with moving iron movement
Format	48 x 48 mm 72 x 72 mm 96 x 96 mm 144 x 144 mm	48 x 48 mm 72 x 72 mm 96 x 96 mm 144 x 144 mm	48 x 48 mm 72 x 72 mm 96 x 96 mm 144 x 144 mm	72 x 72 mm 96 x 96 mm 144 x 144 mm	72 x 72 mm 96 x 96 mm	96 x 96 mm
Movement type	Sprung pivot jewel with silicon oil damping	Sprung pivot jewel with eddy current damping	Sprung pivot jewel with eddy current damping	Sprung pivot jewel with eddy current damping	Sprung pivot jewel with silicon oil damping	Sprung pivot jewel with silicon oil damping
Burden	0.5 VA-15 A then 0.8 VA voltmeters 4.5 VA	See type specific specifications	See type specific specifications	See type specific specifications	2.5 VA	3 VA
Accuracy	1.5% to DIN43780	1.5% to DIN43780	2.5% to DIN43780	0.5% to DIN43780	3%	3% on MDI 1.5% ammeter
Input type	AC current or voltage	DC current or voltage	AC current or voltage	AC voltage	AC current	AC current
Measuring range	6-600 V 100 mA-100 A 48 mm only up to 40 A	50 mV-600 V 100 µA-40 A, 48 mm only 25 A	15-600 V 1m A-100 mA and 1 A & 5 A	57.7 V @ 45 Hz 500 V @ 44 Hz	0-1/1.2 A or 0-5/6 A 8, 15 or 20 minute delays	1-6 A 8, 15 or 20 minute delays 0-5 A/6 A instantaneous
Dielectric voltage withstand test	3 kV AC	3 kV AC	3 kV AC	3 kV AC	3 kV AC	3 kV AC

DIN panel meters – short scale

DIN16257 SYMBOL MEANING FOR CALIBRATION POSITION

VERTICAL



HORIZONTAL

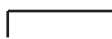

INCLINED

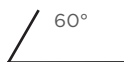

Inclination of dial surface.
Required orientation must always be stated when ordering if other than vertical mounting is required.

GENERAL SPECIFICATIONS

Performance	BS EN60051
Measuring ranges	DIN43701
Accuracy overload	BS EN60051
Dimensions	DIN43700
Scale marking generally to	DIN43802
Magnetic influence	BS EN60051
Safety	BS EN61010-1
Terminals	Clamp strap M4 for up to 25 A. Clamp strap M8 for over 25 A 1/4" spade terminals available for models E243 and E244
Humidity range	Up to 95% RH (non condensing)
Test voltage @50Hz	3 kV RMS for 1 minute
Ammeter ranges	1.0/1.2/1.5/2.5/5/6 and decade multiples thereof
Overload AC current	x 1.2 continuous x 10 for 5 seconds
AC voltage and frequency	x 1.2 continuous x 2 for 5 seconds
Standard calibration	23°C. Calibration at other temperatures available on request
Operating temperature	-20°C to +60°C
Damping time	Less than 3 seconds
Enclosure code	IP52 as standard IP54 on request
Case and base	Grade UL94V0
Case	Dimensions and panel cut out conform to IEC473, DIN43700. Case made from glass filled polycarbonate self-extinguishing and non drip in accordance with UL94V-0
Bezel	Slim-line DIN43802, black as standard
Bezel window	Standard sheet glass, with zero adjusters where appropriate. Non reflecting glass or polycarbonate shatterproof windows are available
Installation	Installations in switchboard panel or mosaic arrangement on equipment or machine with a panel thickness of up to 40 mm in a horizontal or vertical plane
Fixing on panel	Swivel captive fasteners, which can be fixed at either corner
Mounting position	Normal vertical mounting or as indicated on the scale in accordance with DIN16257. A deviation of ±15° is permissible
Insulation group	Insulation resistance more than 5Ω@ 500 V
Environmental	Measurement category III IEC 1010-1 Pollution degree 2 IEC 1010-1 Electrical rating 600 V RMS (920 V peak)
Approvals	EMC, LVD, Lloyds and UL

DIMENSIONS

Moving coil measuring range		Moving iron measuring range	
6 - 60 A	C=67 mm	0 - 30 A	C=64 mm
>60 A	C=78 mm	>30 A	C=67 mm

MAX. PANEL THICKNESS = 40 MM

D	A	B
48 x 48	45 x 45	4
72 x 72	68 x 68	4
96 x 96	92 x 92	4
144 x 144	138 x 138	4

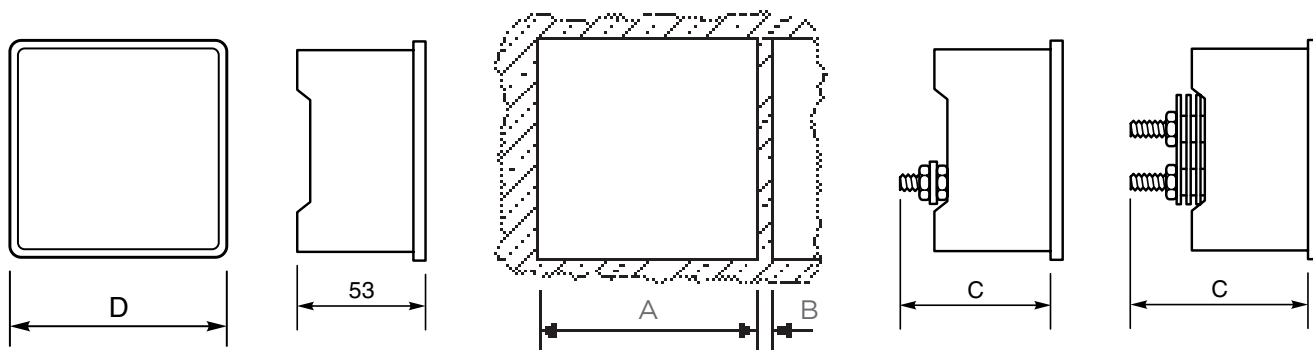

Short scale moving iron AC ammeters and voltmeters



Designed to measure AC current or voltage, these meters indicate true RMS values and are substantially independent of system waveform. Scales are calibrated down to 20%, and ammeters can have overload scales of x2, x3, x5 or x6 for motor start duty. Ammeters can be supplied for use with -/1 A or -/5 A current transformers, whilst voltmeters can be scaled for use with voltage transformers. Meters can be used to measure DC at reduced accuracy.

PRODUCT CODES

Bezel size mm	48	72	96	144
Scale length mm	42	65	94	145
AC ammeter	E242-75A	E243-02A	E244-02A	E246-02A
x2 overload ammeter	E242-752A	E243-022A	E244-022A	-
x3 overload ammeter	E242-753A	E243-023A	E244-023A	-
x5 overload ammeter	E242-755A	E243-025A	E244-025A	-
x6 overload ammeter	E242-756A	E243-026A	E244-026A	-
AC voltmeter	E242-75V	E243-02V	E244-02V	E246-02V

SPECIFICATIONS

Accuracy	Class 1.5
Frequency	50, 60 Hz, (400 Hz on request)
Burden at 50 Hz	Ammeters: 0.5 VA Voltmeters: Up to 4.5 VA maximum
Ratings	Ammeters: 0.5-100 A AC direct connected (40 A for E242-75 A and E246-02 A) Maximum system voltage 600 V AC Low load/high middle, maximum 10 A
Voltmeters	6-600 V

CONNECTIONS

AC ammeter

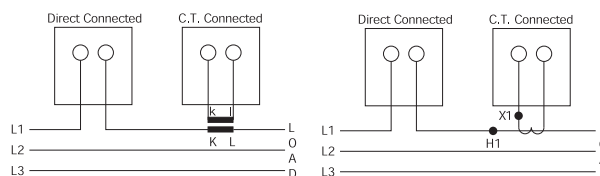

AC VOLT METER

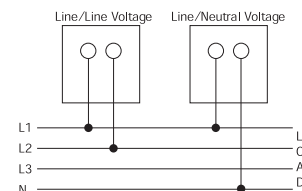

Frequency meters



Frequency meters use an integral electronic converter and a moving coil indicator. These easy to read meters have accuracy Class 0.5.

PRODUCT CODES

Bezel size mm	48	72	96
Scale length mm	42	65	94
Product codes	E242-41S	E243-41S	E244-41S

SPECIFICATIONS

Ratings	100 - 125 V AC 200 - 250 V AC 380 - 440 V AC* 500 V AC* *Use E242-89A and 253-THZ in place of E242-41S for voltages over 380 V Models available for use with VTs
Frequency	0.5%: 45/55 Hz, 55/65 Hz, 45/65 Hz, 360/440 Hz
Burden	4 VA maximum

CONNECTIONS

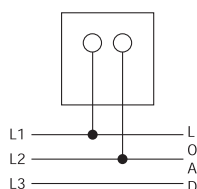

Short scale maximum demand indicators



The thermal/time characteristics of MDI meters monitor the most economic use of cable, fusegear and transformers. The directly heated bimetal element indicates mean RMS current over 8, 15, or 20 minutes, and a red slave pointer shows the highest value reached. The reset knob is wire sealable. Scales are calibrated to match the CT primary plus 20% overload. End values are selected from: 1.2, 1.8, 2.4, 3, 3.6, 4.8, 6, 7.2, 9 amps and their multiples of 10 and 100.

PRODUCT CODES

Bezel size mm	72	96
Scale length mm*	65	94
Product codes		
8 minute time lag		
without limiting CT for use with 5 A CT	E243-16B	E244-16B
15 minute time lag		
without limiting CT for use with 5 A CT	E243-16A	E244-16A
20 minute time lag		
without limiting CT for use with 5 A CT	E243-16J	E244-16J

* Scaled 0/100/120% of CT primary value.

SPECIFICATIONS

Accuracy	Class 3
Options	5 A for use with separate CT 5/5 A saturating CT 1/5 A saturating CT
Burden at 50 Hz	MDI - 2.5 VA, CT - 2 VA
Overload withstand	Standard: 5 x FL for 5 seconds, 10 x FL for 1 second. With saturating CT: 10 x FL for 3 seconds, 20 x FL for 1 second
Frequency	50/60 Hz

CONNECTIONS

Maximum demand indicators

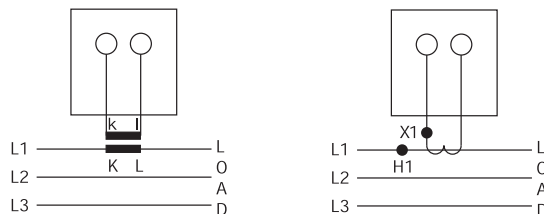

Combined AC ammeter and maximum demand indicators



Where measurement of instantaneous and maximum demand currents are required, these instruments combine both movements in one case. The meter can also replace an existing AC ammeter. Meets the same specifications listed above.

PRODUCT CODES

Bezel size mm	72	96
Scale length mm*	65	94
Product codes		
8 minute time lag		
without limiting CT for use with 5 A CT 3 VA	-	E244-16Q
15 minute time lag		
without limiting CT for use with 5 A CT 3 VA	E243-16C	E244-16C
20 minute time lag		
without limiting CT for use with 5 A CT 3 VA	-	E244-16H

* Scaled 0/100/120% of CT primary value.

SPECIFICATIONS

Accuracy	Moving iron ammeter: Class 1.5 MDI: Class 3
Burden at 50 Hz	MI - 0.5 VA, MDI - 2.5 VA saturating CT - 2 VA

Short scale moving coil DC meters



Moving coil meters are suitable for all DC systems. The linear scale is calibrated down to zero and the accuracy maintained down to 10%. High currents are measured with separate shunts and suitably scaled indicators. Suppressed, centre and offset zero models are available.

PRODUCT CODES

Bezel size mm	48	72	96	144
Scale length mm	42	65	94	145
Product codes				
Ammeters	E242-89A	E243-01A	E244-01A	E246-01A
Ammeters suppressed zero	E242-89R	E243-01R	E244-01R	E246-01R
Ammeters center zero	E242-89C	E243-01C	E244-01C	E246-01C
Voltmeters	E242-89V	E243-01V	E244-01V	E246-01V
Voltmeters suppressed zero	E242-89S	E243-01S	E244-01S	E246-01S
Voltmeters center zero	E242-89N	E243-01N	E244-01N	E246-01N

SPECIFICATIONS

Accuracy	Class 1.5
Ratings	Ammeters: 100 μ A-25 A 4/20 mA suppressed zero 40 A for model E242, E243 and E244 up to 100 A Voltmeters: 50 mV-600 V 1/5 V suppressed zero 50, 60, 75, 100, 150 mV for use with shunts
Impedance	Ammeters: 75 mV internal shunt above 60mA Voltmeters: 1000 Ω /V above 1 V

CONNECTIONS

DC voltmeter

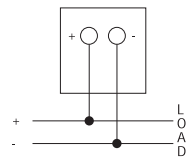

DC ammeter

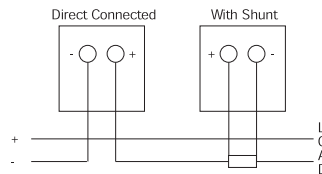

Short scale rectified AC ammeters and voltmeters



For high frequency or linear full scale AC measurements, these instruments measure average values of sinusoidal waveforms and are scaled in RMS values.

The high quality silicon bridge rectifier gives a linear scale down to near zero, where some compression occurs.

PRODUCT CODES

Bezel size mm	48	72	96	144
Scale length mm	42	65	94	145
Product codes				
Ammeters	E242-89B	E243-01B	E244-01B	E246-01B
Voltmeters	E242-89W	E243-01W	E244-01W	E246-01W

SPECIFICATIONS

Accuracy	1.5% ES
Ratings	Ammeters: 250 μ A-1 A AC Over 1 A via CTs
Voltmeters	15 - 600 V AC direct connected. Models available for use with VTs
Frequency	50/60 Hz, (Single frequencies 25 Hz - 1 kHz on request)

CONNECTIONS

AC ammeter

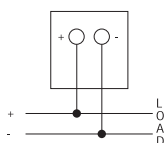

AC voltmeter

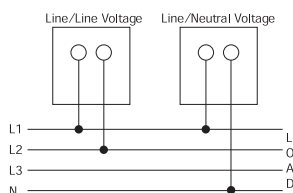

Short scale process indicators



Meters are used to check process functions locally or remotely at centralized controls. These moving coil instruments offer a wide variety of electrical and mechanical readouts and are operated by transducer, tachogenerator, thermocouple, resistance bulb or other DC analog signals. Suppressed, centre and offset zero models are available on request.

PRODUCT CODES

Bezel size mm	48	72	96	144
Scale length mm	42	65	94	145
Product codes				
AC current	E242-89A	E243-01A	E244-01A	E246-01A
AC voltage	E242-89V	E243-01V	E244-01V	E246-0 V
Phase angle	-	E243-014	E244-014	-
Watts	-	E243-015	E244-015	-
VAr	-	E243-016	E244-016	-
VA	-	E243-017	E244-017	-

SPECIFICATIONS

Accuracy	Class 1.5
Ratings	1, 2, 5, 10, 20 mA 4/20 mA suppressed zero

CONNECTIONS

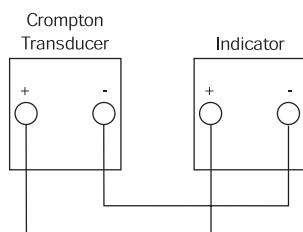

AC ammeters and voltmeters with selector switch

FEATURES

- Integral selector switch
- True RMS measurement
- Scaled for customer VT or CT primary values
- DIN 72 and DIN 96 models
- Terminal cover as standard
- Shock resistant sprung pivot and jewel movement
- x2 overload ammeters

APPROVALS

- IEC61010-1B2001, EMC and LVD



BENEFITS

- Space and time saving
- Competitive cost
- Local indication
- Ease of installation
- Low maintenance
- Customized options and features



These 96 mm and 72 mm units offer Class 1.5 true RMS measurement of three-phase AC voltage or current with various switch notation options. The integral selector switch eliminates the necessity for a separate selector switch, saving valuable panel space and providing installation benefits. These robust moving iron meters incorporate a clapper type repulsion design which utilizes a pivot, hairspring and jewel movement. The bottom jewel is oil filled to provide damping while the top is sprung for resilience. Voltmeters are manufactured with internal voltage dropper resistors.

PRODUCT CODES - AC AMMETERS WITH SELECTOR SWITCH

Code	Case size	Full scale deflection	Switch notation
E243-02E-G-LS** -C7-AMP3	72 mm	0/5 A AC	OFF L1 L2 L3
E244-02E-G-LS** -C7-AMP3	96 mm	0/5 A AC	OFF L1 L2 L3
E243-022E-G-LS** -C7-AMP3	72 mm	0/5/10 A AC	OFF L1 L2 L3
E244-022E-G-LS** -C7-AMP3	96 mm	0/5/10 A AC	OFF L1 L2 L3
E243-02E-G-LA** -C7-AMP3	72 mm	0/1 A AC	OFF L1 L2 L3
E244-02E-G-LA** -C7-AMP3	96 mm	0/1 A AC	OFF L1 L2 L3
E243-022E-G-LA** -C7-AMP3	72 mm	0/1/2 A AC	OFF L1 L2 L3
E244-022E-G-LA** -C7-AMP3	96 mm	0/1/2 A AC	OFF L1 L2 L3

**Insert applicable CT primary value.

APPLICATIONS

- Switchgear
- Distribution systems
- Generator sets
- Control panels
- Energy management
- Building management

PRODUCT CODES - AC VOLTMETERS WITH SELECTOR SWITCH

Code	Case size	Full scale deflection	Switch notation	3-phase
E243-02Q-G-PM** -C7-SW6	72 mm	0/120 V AC	OFF L1L2 L2L3 L3L1	3W
E243-02Q-G-PZ** -C7-SW6	72 mm	0/150 V AC	OFF L1L2 L2L3 L3L1	3W
E243-02Q-G-PZ-PZ-C7-SW6	72 mm	0/150 V AC	OFF L1L2 L2L3 L3L1	3W
E243-02Q-G-RX-RX-C7-SW6	72 mm	0/300 V AC	OFF L1L2 L2L3 L3L1	3W
E243-02Q-G-SF-SF-C7-SW3	72 mm	0/500 V AC	L1L3 L1L2 L2L3 L3N L2N L1N	4W
E243-02Q-G-SJ-SJ-C7-SW3	72 mm	0/600 V AC	L1L3 L1L2 L2L3 L3N L2N L1N	4W
E244-02Q-G-PZ** -C7-SW6	96 mm	0/150 V AC	OFF L1L2 L2L3 L3L1	3W
E244-02Q-G-PZ-PZ-C7-SW6	96 mm	0/150 V AC	OFF L1L2 L2L3 L3L1	3W
E244-02Q-G-RX-RX-C7-SW6	96 mm	0/300 V AC	OFF L1L2 L2L3 L3L1	3W
E244-02Q-G-SF-SF-C7-SW3	96 mm	0/500 V AC	L1L3 L1L2 L2L3 L3N L2N L1N	4W
E244-02Q-G-SF-SF-C7-SW3	96 mm	0/600 V AC	L1L3 L1L2 L2L3 L3N L2N L1N	4W

**Insert applicable VT primary and secondary value, e.g. 15 kV/110 V.

PRODUCT CODES - OPTIONS

Description
Non reflecting glass window
Red supplementary pointer, externally adjustable
Red index mark (triangle)

Please state any required options at time of ordering.

CONNECTIONS

AC ammeter with selector switch

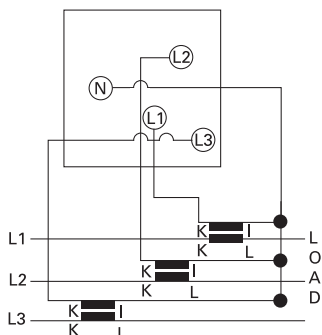

AC voltmeters 3-phase 3-wire

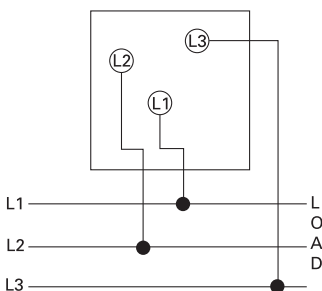

AC voltmeters 3-phase 4-wire

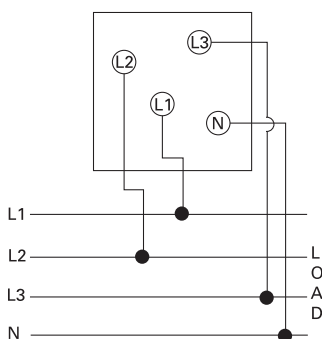

GENERAL SPECIFICATIONS

Accuracy	1.5% of full scale deflection (FSD)
Input rating	Ammeter: 1 A, 5 A 1/2 A or 5/10 A moving iron, direct connected Voltmeter: 120, 300, 500 and 600 V AC
Frequency	50, 60 Hz (400 Hz on request)
Burden at 50 Hz	Ammeters: 0.5 VA Voltmeters: 4-5 VA max
Overload ammeter	2 x In continuous for 2 minutes, 4 x In for 1 minute
Overload voltmeter	1.2 x continuous 2 x for 5 seconds
Movement	Moving iron shock resistant sprung pivot and jewel
Scale length	DIN72: 54 mm DIN96: 97 mm
Enclosure style	Panel mount to DIN42700
Enclosure material	Grade UL94 VO
Bezel style	Black matt DIN43802
Window	Standard sheet glass
Terminals	M4 captive screw clamp
Fixing	2 corner fixing clamps with tensioning thumb screws
Mounting position	Vertical mount to DIN16257, inclination of dial surface $\pm 15\%$
Damping time	Less than 3 seconds
Compliant with	IEC61010-1B2001, CAT III 600V, EMC and LVD
Operating temperature	-20°C to +55°C
Storage temperature	-40°C to +75°C
Calibration temperature	23°C
Relative humidity	95% (non condensing)
Dimensions	96DIN: 96 mm high x 96 mm wide x 63 mm deep 72DIN: 72 mm high x 72 mm wide x 63 mm deep
Panel cut out	DIN96: 92 mm x 92 mm DIN72: 68 mm x 68 mm
IP protection	IP40
Weight	E243-02E 275 g E243-02Q 300 g E244-02E 360 g E244-02Q 390 g

DIMENSIONS

72DIN models

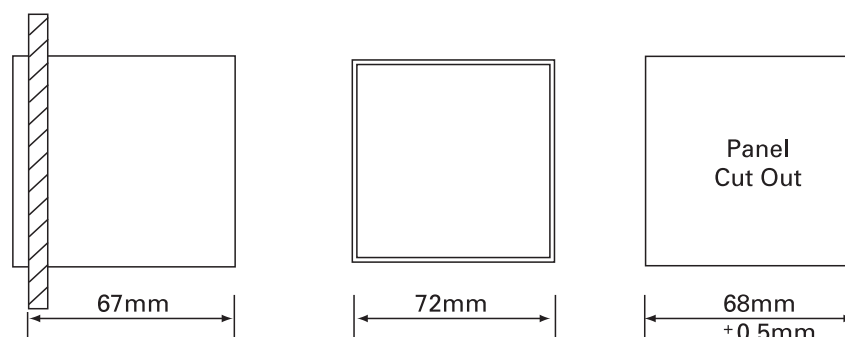

96DIN models

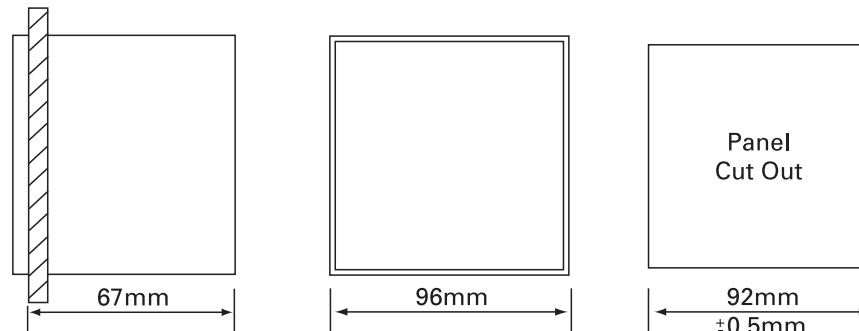

DIN panel meters - long scale

FEATURES

- DIN 48, 72 and 96mm case style
- Slide in dials
- Moving coil movement
- Terminal covers
- Resistance to mechanical impact and vibrations



APPLICATIONS

- Switchgear
- Distribution systems
- Generator sets
- Control panels
- Energy management
- Building management
- Utility power monitoring
- Process control
- Motor control

APPROVALS

- BV approved



BENEFITS

- Local indication
- Ease of installation
- Minimal training
- Low maintenance
- Customized options and features

MOVING COIL METER

Centre cored, self shielding moving coil movement, made of light quality material which is not sensitive to external electromagnetic fields and is resistant to mechanical impacts and vibrations.

FREQUENCY METER

Meter uses a 100 microamps 4000 ohm movement driven by an EMC hard frequency conversion circuit.

DIALS, SCALES AND POINTERS

Standard dials are white matt with black printed scales and bar knife-edge pointers. Black dials with white or yellow scales and pointers are also available.

Standard options include red supplementary pointers, and non-reflecting glass. Other options available on request.

GENERAL SPECIFICATIONS

Performance	BS EN60051 1 1/2 % of full scale deflection (FSD)
Measuring ranges	DIN43701
Accuracy overload	BS EN60051
Dimensions	DIN43700 see detail on following page
Scale marking generally to	DIN43802
Magnetic influence	BS EN60051
Safety	BS EN61010-1
Terminals	Clamp strap M4 for up to 15 A. Clamp strap M6 for 15 to 40 A.
Humidity range	Up to 75% RH (non condensing)
Test voltage @50Hz	2 kV RMS for 1 minute
Overload AC current	x 1.2 continuous, or x 10 for 5 seconds max
AC voltage and frequency	x 1.2 continuous, or x 2 for 5 seconds max
Standard calibration	23°C. Calibration at other temperatures available on request
Operating temperature	-10°C to +55°C
Damping time	Less than 3 seconds
Enclosure code	IP52 as standard IP54 on request
Case and base	Grade UL94V0
Case	Dimensions and panel cut out conform to IEC473, DIN43700. Case made from glass filled polycarbonate self-extinguishing and non drip in accordance with UL94V-0
Bezel	Slim-line DIN43802, black as standard
Bezel window	Standard sheet glass, with zero adjusters where appropriate. Non reflecting glass and polycarbonate windows are available
Installation	Installations in switchboard panel or mosaic arrangement on equipment or machine with a panel thickness of up to 40 mm in a horizontal or vertical plane
Fixing on panel	2 captive fasteners (optional 4 on request)
Mounting position	Normal vertical mounting or as indicated on the scale in accordance with DIN16257. A deviation of ±15° is permissible
Insulation group	Insulation resistance more than 5 MΩ@ 500 V
Environmental	Measurement category III IEC 1010-1 Pollution degree 2 IEC 1010-1 Electrical rating 600 V RMS (920 V peak)
Approvals	EMC and LVD, BV Approval

DIN panel meters - dimensions

DIN16257 SYMBOL MEANING FOR CALIBRATION POSITION

VERTICAL



HORIZONTAL



INCLINED

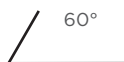

Inclination of dial surface.

Required orientation must always be stated when ordering if other than vertical mounting is required.

PRODUCT DIMENSIONS

Description		M242-01*, M242-02*, M242-05*	M243-01*, M243-02*, M243-05*	M244-01*, M244-02*, M244-05*, M244-41R*, M244-41E*, M244-41L*, M244-41D*, M244-80*	M246-01*, M246-02*, M246-05*
Bezel (mm)	a	48	72	96	144
Panel cut out (mm)	b	45 (+0.6)	68 (+0.8)	92 (+0.8)	138 (+1.0)
Bezel height (mm)	c	5.0	5.5	5.5	8.0
Terminal cover (mm)	d	42.5	66.5	90	90

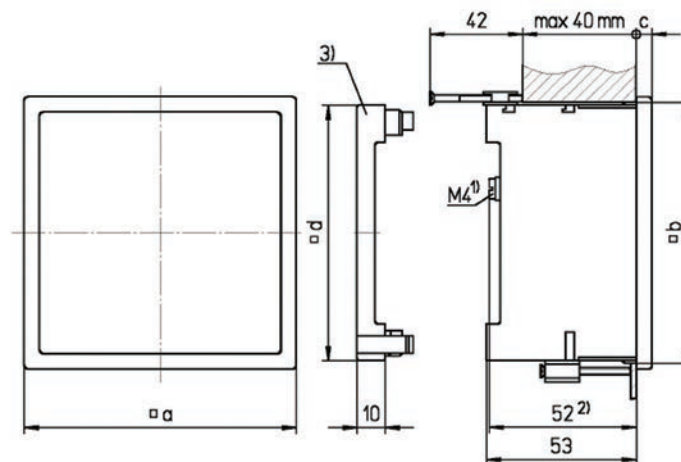

M242-01*, M242-02*, M242-05*, M243-01*, M243-02*, M243-05*,
M244-01*, M244-02*, M244-41R*, M244-41E*. M244-05*, M246-01*,
M246-02*, M246*-05*

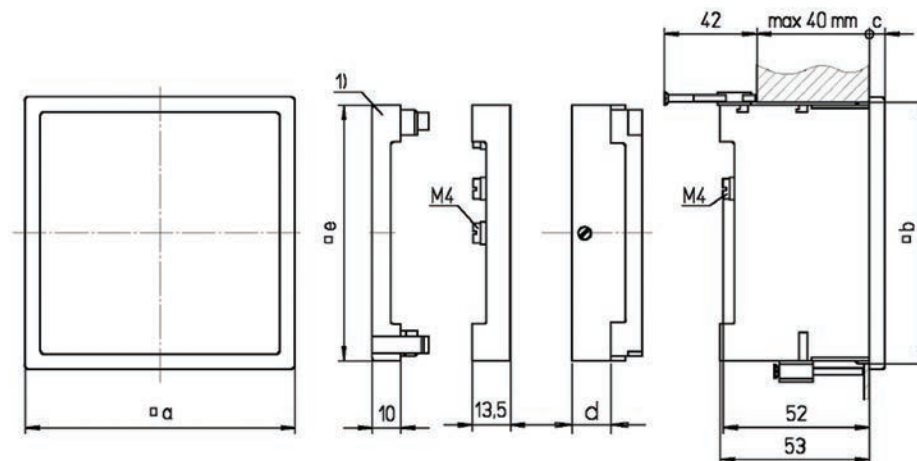

M244-41L*, M244-41D*, M244-41S*,
M244-80* (d = 27.3 mm)

Long scale rectified AC ammeter and voltmeter

FEATURES

- Measures AC current or voltage
- CT connected ammeters
- Direct and VT connected voltmeters
- Linear scaling
- 240° long scale version
- x6 overload



APPLICATIONS

- AC switchgears, panels and distribution boards

CONSTRUCTION

- Mean value measurement of current or voltage
- Containing germanium diodes of low reverse current
- Slot in screw fixing

APPROVALS

- CE marked



BENEFITS

- Easy to operate
- Exchangeable dial
- Low consumption
- Terminal cover included

SPECIFICATION

Accuracy class	1.5
Maximum continuous overload	1.2 x I _n , 1.2 x U _n
Maximum short duration overload	10xI _n - 9x0.5s+1x5s/60s - 2xU _n - 9x0.5s+1x5s/60s
Frequency	50/60 Hz

PRODUCT CODES

Bezel size (mm)	48	72	96	144
Scale length (mm)	71	113	155	235
AC ammeter rectified 240°	M242-05B	M243-05B	M244-05B	M246-05B
AC voltmeter rectified 240°	M242-05W	M243-05W	M244-05W	M246-05W
AC ammeter rectified 240° x6 overload		M243-056B	M244-056B	

Standard input ranges

AC ammeter rectified 240° scaling (0/x A) meter (0/x A), (0/ x A x6), 1, 5A M243, M244	1, 5 A (M242-05B delivered with separated current transformer)
AC voltmeter rectified 240° scaling (0/x V)	20, 15, 20, 30, 60, 100, 150, 250, 300 (limit at M242), 400, 500, 600 V
AC voltmeter for VT connection (0/x V)	120 V (for use with VT's x/100 V), 132 V (for use with VT's x/110 V), 144 V (for use with VT's 120 V), 125 V, 137.5 V, 150 V (for use with some VT's having primary voltage less than 1 kV)

CONNECTION DIAGRAMS

AC ammeter

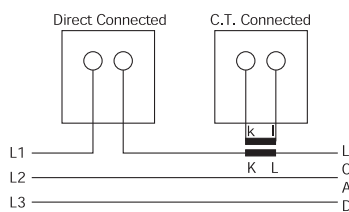

AC voltmeter

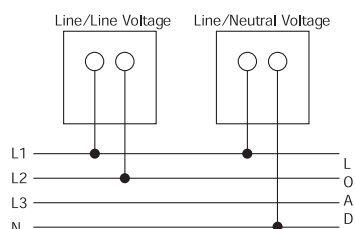

ORDER DATA/EXAMPLES

AMMETER

- 1) Select type: M243-05B,
- 2) Specify input: 0-1 A,
- 3) Specify scaling: 0-1 kA,
- 4) Specify frequency: 50/60 Hz

VOLTMETER

- 1) Select type: M244-05 W,
- 2) Specify input: 0-500 V,
- 3) Specify scaling: 0-500 V,
- 4) Specify frequency: 50/60 Hz

VOLTMETER, VT CONNECTED

- 1) Select type: M244-05 W,
- 2) Specify input: 0-120 V,
- 3) Specify scaling: 0-12 kV,
- 4) Specify frequency: 50/60 Hz,
- 5) Specify VT ratio: 10/0.1 kV

Long scale DC ammeter and voltmeter

FEATURES

- Measures DC current or voltage
- Direct and shunt connected ammeters
- Direct connected voltmeters
- Live zero ammeters and voltmeters
- Centre zero ammeters and voltmeters
- Linear scaling
- 240° long scale version



APPLICATIONS

- DC switchgears, panels and distribution boards
- Control boards
- Process indication
- Battery supervision

CONSTRUCTION

- Magnet core none sensitive to external fields
- Slot in screw fixing

APPROVALS

- CE marked



BENEFITS

- Easy to operate
- Exchangeable dial
- Terminal cover included

SPECIFICATION

Accuracy class	1.5
Maximum continuous overload	1.2 x I _n , 1.2 x U _n
Maximum short duration overload	10xI _n - 9x0.5s+1x5s/60s, 2xU _n - 9x0.5s+1x5s/60s

PRODUCT CODES

Bezel size (mm)	48	72	96	144
Scale length (mm)	71	113	155	235
DC ammeter 240°	M242-05A	M243-05A	M244-05A	M246-05A
DC voltmeter 240°	M242-05V	M243-05V	M244-05V	M246-05V
DC ammeter 240° live zero	M242-05R	M243-05R	M244-05R	M246-05R
DC voltmeter 240° live zero	M242-05S	M243-05S	M244-05S	M246-05S
DC ammeter 240° center zero	M242-05C	M243-05C	M244-05C	M246-05C
DC voltmeter 240° center zero	M242-05N	M243-05N	M244-05N	M246-05N

Standard input ranges

DC ammeter 240° scaling (0/x A)	1, 1.5, 2.5, 4, 5, 6, 10, 15, 20, 25 (limit on M242), 30, 40, 50, 60 A
DC ammeter 240° scaling, process and shunt indicators	0-1, 0-5, 0-10, 0-20, 4-20 mA, 0-50, 0-60, 0-75 mV
DC ammeter 240° scaling, center zero (x-0-x A)	1-0-1, 1.5-0-1.5, 2.5-0-2.5, 4-0-4, 5-0-5, 6-0-6, 10-0-10 (limit on M242), 15-0-15, 20-0-20, 25-0-25, 30-0-30A
DC ammeter 240° scaling, center zero process and shunt indicators	1-0-1, 5-0-5, 10-0-10, 20-0-20 mA, 50-0-50, 60-0-60, 75-0-75 mV
DC voltmeter 240° scaling (0/x V)	10, 15, 20, 30, 60, 100, 150, 250, 300 (limit on M242), 400, 500, 600 V
DC voltmeter 240° scaling, process indicators	1-5, 2-10 V
DC voltmeter 240° scaling, center zero (x-0-x V)	10-0-10, 15-0-15, 20-0-20, 30-0-30, 60-0-60, 100-0-100, 150-0-150 (limit on M242) 250-0-250, 300-0-300 V

CONNECTION DIAGRAMS

DC voltmeter

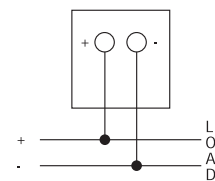

DC ammeter

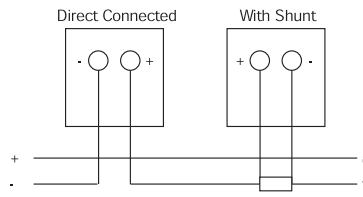

Transducer indicator

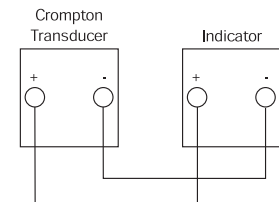

ORDER DATA/EXAMPLES

AMMETER

EXAMPLE A

- 1) Select type: M243-05 A,
- 2) Specify input: 0-10 A,
- 3) Specify scaling: 0-10 A

EXAMPLE B

- 1) Select type: M244-05R,
- 2) Specify input: 4-20 mA,
- 3) Specify scaling: 0-100 MVA

EXAMPLE C

- 1) Select type: M244-05C,
- 2) Specify input: 60-0-60 mV,
- 3) Specify scaling: 150-0-150 A

VOLTMETER

EXAMPLE A

- 1) Select type: M244-05 V,
- 2) Specify input: 0-15 V,
- 3) Specify scaling: 0-15 V

EXAMPLE B

- 1) Select type: M244-05S,
- 2) Specify input: 2-10 V,
- 3) Specify scaling: 0-100 %

EXAMPLE C

- 1) Select type: M242-05N,
- 2) Specify input: 10-0-10 V,
- 3) Specify scaling: 20-0-20 A

Long scale frequency meters with pointers or reeds

FEATURES

- Measures AC frequencies
- Pointer type available as 240° long scale version
- Reed type available with
 - 13 reeds (47-53 Hz, 57-63 Hz)
 - 21 reeds (45-55 Hz, 55-65 Hz)
- Direct or VT connected

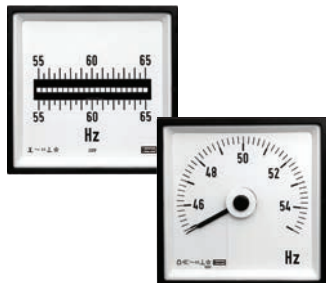

APPLICATIONS

- AC switchgears, panels and distribution boards
- Control board
- Generator sets

CONSTRUCTION

- Pointer type contains internal transducer, powered from input voltage and moving coil meter
- Reed type uses steel reeds in an electromagnetic field. Reeds are calibrated to its individual frequency to vibrate in resonance with the electromagnet and vibrates at full amplitude

APPROVALS

- CE marked
- BV approved



BENEFITS

- Easy to operate
- High visibility
- Terminal cover included
- Marine approved

SPECIFICATION

Accuracy class	0.5 - 1.2 x Un continuously
Overload	1.5 x Un for 2 hours (pointer type only) - 2 x Un for 5 seconds - 1 VA at nominal voltage 57-110 V and 230 V
Burden pointer type	1.7 VA at nominal voltage 400V - 2VA at nominal voltage 500 V
Burden reed type	0.7 ... 1.2 VA at nominal voltage 110-230 V - 1.4 ... 2 VA at all other nominal voltages

PRODUCT CODES

Bezel size (mm)	96	96	96	96
Scale length (mm)	95	135	-	-
Frequency meter 240°	-	M244-41L	-	-
Frequency meter 13 reeds	-	-	M244-41R	-
Frequency meter 21 reeds	-	-	-	M244-41R

Standard input ranges

Pointer type	57-110 V, 400V +/- 20%, 500V +/-20%
Reed type	100V, 110V, 230V, 400V +/- 20%, 500V +/-20%

Scaling

13 reeds on reed type meters with scaling	47-50-53 Hz, 57-60-63 Hz
21 reeds on reed type meters with scaling	45-50-55 Hz, 55-60-65 Hz
Scaling 240° pointer types	45-50-55 Hz, 55-60-55 Hz, 45-55-65 Hz

CONNECTION DIAGRAMS

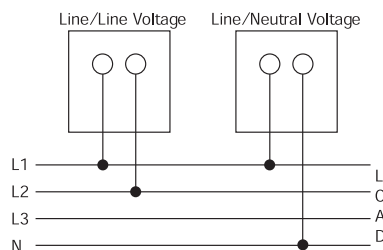

ORDER DATA/EXAMPLES

POINTER TYPE 240°

- 1) Select type: M244-41L,
- 2) Specify input voltage: 57-110 V,
- 3) Specify frequency: 45/65 Hz,
- 4) Specify scaling: 45-55-65 Hz

REED TYPE 13 REEDS

- 1) Select type: M244-41R,
- 2) Specify input voltage: 230 V,
- 3) Specify frequency: 47/53 Hz,
- 4) Specify scaling: 47-50-53 Hz

REED TYPE 21 REEDS

- 1) Select type: M244-41R,
- 2) Specify input voltage: 110 V,
- 3) Specify frequency: 55/65 Hz,
- 4) Specify scaling: 55-60-65 Hz

Elapsed time meters (hours run meters)



Elapsed time meters (ETM) or hours-run meters monitor “ON/RUN” time of plant and equipment, allowing the user to effectively control production efficiency, cost estimation and service period monitoring for preventative maintenance. Time is measured in increments of 0.01h up to 99999.99 hours after which the meter automatically resets to zero. Meters are non-resettable before this time to prevent accidental resetting.

SPECIFICATIONS

AC	
Display	99999.99
Voltage	100-125 V AC 200-250 V AC 380-440 V AC
Frequency	50 or 60 Hz
Operating temperature	-25°C to +80°C
IP Protection	IP52
Burden	1 VA (100-125 V AC) 2 VA (200-250 V AC) 3.5 VA (380-440 V AC)
DC	
Display	99999.99
Voltage	12-36 V DC 10-80 V DC 110 V DC
Operating temperature	-20°C to +70°C
IP Protection	IP52
Burden	0.5 VA (12 - 36 V AC) 1 VA (10-80 V AC) 1.5 VA (110 V AC) 0.5 VA (6 - 30 V) 1 VA (36 - 80 V)

Bezel size product codes	48 mm	72 mm	96 mm
100-125 V AC 50 Hz	M242-155-G-PL-ZH-C5	M243-155-G-PL-ZH-C5	M244-155-G-PL-ZH-C5
200-250 V AC 50 Hz	M242-155-G-RN-ZH-C5	M243-155-G-RN-ZH-C5	M244-155-G-RN-ZH-C5
380-440 V AC 50 Hz	M242-155-G-RY-ZH-C5	M243-155-G-RY-ZH-C5	M244-155-G-RY-ZH-C5
100-125 V AC 60 Hz	M242-156-G-PL-ZH-C6	M243-156-G-PL-ZH-C6	M244-156-G-PL-ZH-C6
200-250 V AC 60 Hz	M242-156-G-RN-ZH-C6	M243-156-G-RN-ZH-C6	M244-156-G-RN-ZH-C6
380-440 V AC 60 Hz	M242-156-G-RY-ZH-C6	M243-156-G-RY-ZH-C6	M244-156-G-RY-ZH-C6
6-30 V DC	-	M243-157-G-BU-ZH-DC	M244-157-G-BU-ZH-DC
12-36 V DC	M242-157-G-BU-ZH-DC	-	-
10-80 V DC	-	M243-157-G-NR-ZH-DC	M244-157-G-NR-ZH-DC
36-80 V DC	M242-157-G-NR-ZH-DC	-	-
110 V DC	M242-157-G-PM-ZH-DC	M243-157-G-PM-ZH-DC	M244-157-G-PM-ZH-DC

Elapsed time/hours
run meters AC

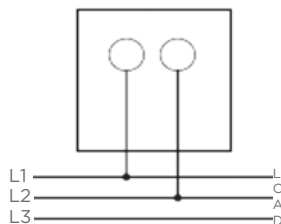

Elapsed time/hours
run meters DC

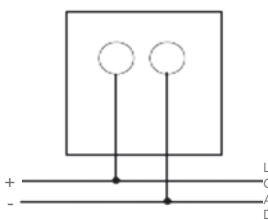

Dual voltmeter and frequency meter

FEATURES

- Measures AC frequencies of two independent systems
- Pointer type dual voltmeter and frequency meter with two independent 90° short scale movements
- Reed type available with two independent measuring circuits - 21 reeds (45-55 Hz, 55-65 Hz)
- Direct or VT connected

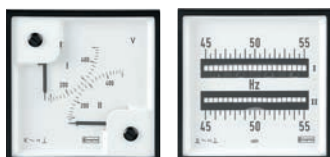

APPLICATIONS

- AC switchgears, panels and distribution boards
- Control board
- Generator sets

CONSTRUCTION

- Pointer type contains internal transducer, powered from input voltage and moving coil meter
- Reed type uses steel reeds in an electromagnetic field. Reeds are calibrated to its individual frequency to vibrate in resonance with the electromagnet and vibrates at full amplitude
- Slot in screw fixing

ORDER DATA/EXAMPLES

DUAL VOLTMETER - LV DIRECT CONNECTED

- 1) Select type: M244-80L,
- 2) Specify input voltage: 500 V,
- 3) Specify scaling: 0-500 V,
- 4) Specify frequency: 50 Hz

APPROVALS

- CE marked



BENEFITS

- Easy to operate
- High visibility
- Terminal cover included
- Marine approved

GENERAL SPECIFICATION

Accuracy class dual voltmeter	1.5
Accuracy class dual frequency meter - pointer type	1
Accuracy class dual frequency meter - reed type	0.5
Overload	10xIn - 9x0.5s+1x5s/60s
Dual voltmeter	2xUn - 9x0.5s+1x5s/60s
Dual frequency meter - pointer type	1.2 x Un continuously, 1.5 x Un for 2 hours (pointer type only)
Dual frequency meter - reed type	2 x Un for 5 seconds
Burden frequency meter - pointer type	1 VA at nominal voltage 57 - 110 V and 230 V - 1.7 VA at nominal voltage 400 V - 2 VA at nominal voltage 500 V
Burden frequency meter - reed type	0.7 ... 1.2 VA at nominal voltage 110-230 V - 1.4 ... 2 VA at all other nominal voltages

PRODUCT CODES

Bezel size (mm)	96	96	96	-
Scale length (mm)	41	41	-	-
Voltmeter meter 2 x 90°	M244-80L	-	-	-
Frequency meter 2 x 90°	-	M244-41D	-	-
Frequency meter 2 x 21 reeds	-	-	M244-41E	-

Standard input ranges

Dual voltmeter (direct connected)	300 V, 500 V
Dual voltmeter (VT connected)	120 V (for use with VT's x/100 V), 132 V (for use with VT's x/110 V), 144 V (for use with VT's 120 V), 125 V, 137.5 V, 150 V (for use with some VT's having primary voltage less than 1 kV)
Dual frequency meter - pointer type	57-110 V, 400 V +/- 20%, 500 V +/-20%
Dual frequency meter - reed type	100 V, 110 V, 230 V, 400 V +/- 20%, 500 V +/-20%

Scaling

Dual voltmeter	Specify to suit application
Dual frequency meter - pointer type	45-50-55 Hz, 55-60-55 Hz, 45-55-65 Hz
Dual frequency meter - reed type	45-50-55 Hz, 55-60-65 Hz

CONNECTION DIAGRAMS

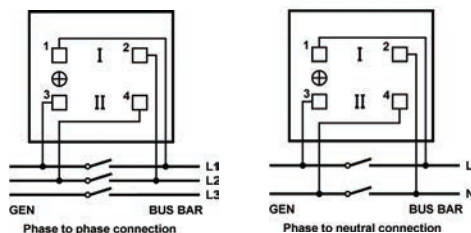

DUAL VOLTMETER - VT CONNECTED

- 1) Select type: M244-80L,
- 2) Specify input: 0-120 V,
- 3) Specify scaling: 0-12 kV,
- 4) Specify frequency: 50 Hz,
- 5) Specify VT ratio: 10/0.1 kV

DUAL FREQUENCY METER - POINTER TYPE

- 1) Select type: M244-41D,
- 2) Specify input voltage: 400 V,
- 3) Specify frequency: 45/65 Hz,
- 4) Specify scaling: 45-55-65 Hz

DUAL FREQUENCY METER - REED TYPE

- 1) Select type: M244-41E,
- 2) Specify input voltage: 110 V,
- 3) Specify frequency: 55/65 Hz,
- 4) Specify scaling: 55-60-65 Hz

Phase sequence indicators



Electronic phase sequence indicators ensure correct phase rotation and the presence of all 3-phase supplies. Incorrect or loss of phase can cause serious damage in a wide range of electrical machines. Ship-to-shore supplies, mobile generators and remote installations are particularly vulnerable to this problem.

Voltage	151/300 V, 301/500 V 100/150 V (Model 244-12P only)
Frequency	50/60 Hz
Burden	2.5 VA/phase

DIMENSIONS

Bezel size mm	72	96
Product codes		
Phase sequence indicator	243-12P	244-12P

CONNECTIONS

Phase sequence indicators

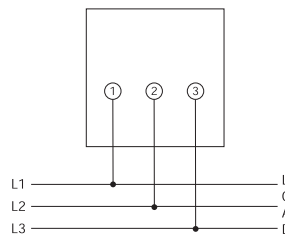

Phase angle meters

Phase angle meters indicate the phase displacement between current and voltage. They are used in applications where the phase angle must be monitored, for example with tariffs having VAR penalties, or to optimize generator power delivery.

PRODUCT CODES - SHORT-SCALE MODELS

DIMENSIONS

Bezel size mm	72	96
Scale length mm	65	94
Product codes		
3-phase 3/4-wire balanced load	E243-42A	E244-42A

SPECIFICATIONS

Accuracy	Class 1.5
Ratings	Current: 1 A or 5 A for CTs Voltage: 110 V, 240 V, 380 V & 400 V for VT use
Frequency	50 Hz, 60 Hz
Burden at 50 Hz	Current: 1 VA Voltage: 3 VA per phase
Current range	20-120%

CONNECTIONS

3-phase, 3/4-wire balanced systems

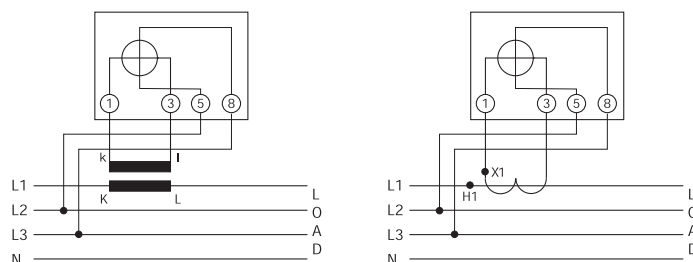

Power factor meters

FEATURES

- Indicates Power factor of electrical systems
- Several voltage ranges available
- Current connection via “through hole” CT on the instrument. No need to interrupt wiring from CT

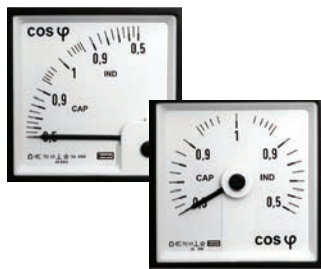

APPLICATIONS

- AC switchgears, panels and distribution boards
- Control boards
- Generator sets

CONSTRUCTION

- Instruments operate on a fast sampling method of input quantities (current and voltage) of the connected phases
- Meters include “through hole” CT connection, voltage dividers, internal microprocessor and power supply unit
- Slot in screw fixing

APPROVALS

- CE marked



BENEFITS

- Easy to operate
- High visibility
- Terminal cover included
- Low self consumption
- Internal power supply from voltage input

GENERAL SPECIFICATION

Accuracy class	1.5
Maximum continuous overload	3 x In, 1.5 x Un
Maximum short duration overload	25 x In for 30 seconds, 50 x In for 1 second, 2 x Un for 10 seconds
Voltage burden	<0.1 VA per phase
Current burden	<0.1 VA per phase
Frequency	50/60 Hz

PRODUCT CODES

Bezel size (mm)	96	96	96	96	96
Scale length (mm)	95	95	95	95	95
Power factor meter 90°	M244-420 single-phase	M244-421 3P/3W balanced	M244-42C 3P/4W balanced	M244-423 3P/3W unbalanced	M244-424 3P/4W unbalanced
Bezel size (mm)	96	96	96	96	96
Scale Length (mm)	135	135	135	135	135
Power factor meter 240°	M244-135 single-phase	M244-136 3P/3W balanced	M244-13D 3P/4W balanced	M244-138 3P/3W unbalanced	M244-139 3P/4W unbalanced
Standard input ranges					
Single-phase, 3P/4W balanced, 3P/4W unbalanced	57.7 V L-N/1 A, 57.7 V L-N/5 A, 63.5 V L-N/1 A, 63.5 V L-N/5 A, 69.3 V L-N/1 A, 9.3 V L-N/5 A, 230 V L-N/1 A, 230 V L-N/5 A, 240 V L-N/1 A, 240 V L-N/5 A, 254 V L-N/1 A, 254 V L-N/5 A				
3P/3W balanced, 3P/3W unbalanced	100 V L-L/1 A, 100 V L-L/5 A, 110 V L-L/1 A, 110 V L-L/5 A, 400 V L-L/1 A, 400 V L-L/5 A, 415 V L-L/1 A, 415 V L-L/5 A, 440 V L-L/1 A, 440 V L-L/5 A				
Scaling	0.5/1/0.5 CAP/IND or 0.8/1/0.2 CAP/IND or 0.1/1/0/1/0.1 CAP/IND				

CONNECTION DIAGRAMS

Single-phase

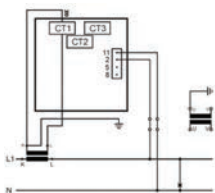

3-phase 4-wire (3P/4W) balanced

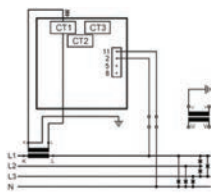

3-phase 4-wire (3P/4W) unbalanced

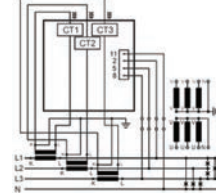

3-phase 3-wire (3P/3W) balanced

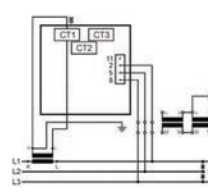

3-phase 3-wire (3P/4W) unbalanced

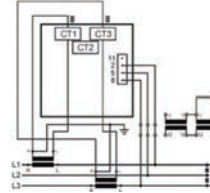

ORDER DATA/EXAMPLES

SINGLE-PHASE

- 1) Select type: M244-420,
- 2) Specify input voltage and current: 230 V L-N/5 A,
- 3) Specify scaling: 0.5/1/0.5 CAP/IND
- 4) Specify frequency: 50/60 Hz,

3-PHASE 4-WIRE BALANCED

- 1) Select type: M244-13D,
- 2) Specify input voltage and current: 69.3 V L-N/1 A,
- 3) Specify scaling: 0.5/1/0.5 CAP/IND,
- 4) Specify frequency: 50/60 Hz

3-PHASE 4-WIRE UNBALANCED

- 1) Select type: M244-424,
- 2) Specify input voltage and current: 230 V L-N/5 A,
- 3) Specify scaling: 0,8/1/0,2 CAP/IND
- 4) Specify frequency: 50/60 Hz

3-PHASE 3-WIRE BALANCED

- 1) Select type: M244-136,
- 2) Specify input voltage and current: 110 V L-L/5 A,
- 3) Specify scaling: 0.5/1/0.5 CAP/IND,
- 4) Specify frequency: 50/60 Hz

3-PHASE 3-WIRE UNBALANCED

- 1) Select type: M244-138,
- 2) Specify input voltage and current: 415 V L-L/1 A,
- 3) Specify scaling: 0.5/1/0.5 CAP/IND,
- 4) Specify frequency: 50/60 Hz

LED synchroscope



360° LED SYNCHROSCOPE AND SYNCHRO CHECK RELAY

Where manual paralleling of two AC systems is desired, the frequency of both systems can be monitored by an LED synchroscope. The systems are synchronized when the green LED is lit in the 12 o'clock position. The instrument is rated for continuous operation and connection. For the semi-automatic paralleling of two AC systems, the voltage, phase displacement and the frequency of both systems can be monitored by this LED synchroscope and synchro check relay. Controls for voltage, phase angle, and time delay are provided. The systems are synchronized when the green triangular LEDs are lit together with the GEN/BUS green LEDs. A dead bus option is also available.

SPECIFICATIONS

Ratings voltage	63.5, 110, 120, 220, 230, 240, 380, 400, 415, 440, 480 V 110/120 V (115 V nominal) 220/240 V (230 V nominal) 380/480 V (430 V nominal) Volts AC or via VT
Frequency	40/65 Hz
Burden at 50Hz / 60Hz	4 VA maximum Suitable for 1 or 3-phase systems
Safety	IEC1010-1 (300 V AC RMS installation degree 2)
Dielectric	4 kV rms for 1 minute
Isolation	BUS/GEN/RELAY
Vibration	To Lloyds shipping specification
*Phase difference	+0-20°, +2%
*Voltage difference	+0-20%, +/-2% 0-10% for models G and H
*Time delay	0-2.5 seconds +10%
*Accuracy	Synchronization at T.DC is +1°

*Only for the 360° LED synchroscope and synchro check relay.

DIMENSIONS

Bezel size mm	96	96	96
Scale length mm	360° LED	360° LED	360° LED
3- or 4-wire 40-65 Hz	Synchroscope	Synchroscope and synchro check	Synchroscope and synchro check relay (dead bus)
Product codes			
110/120 V	-	244-14GG-POBX	244-14HG-POBX
220/240 V	-	244-14GG-R5BX	244-14HG-R5BX
380/480 V	-	244-14GG-RUBX	244-14HG-RUBX
63.5 V	244-14AG-NXY	244-14LG-NXB	244-14DG-NXB
110 V	244-14AG-PMY	244-14LG-PMB	244-14DG-PMB
220 V	244-14AG-R4Y	244-14LG-R4B	244-14DG-R4B
230 V	244-14AG-RQY	244-14LG-RQB	244-14DG-RQB
240 V	244-14AG-RRY	244-14LG-RRB	244-14DG-RRB
380 V	244-14AG-RUY	244-14LG-RUB	244-14DG-RUB
400 V	244-14AG-SCY	244-14LG-SCB	244-14DG-SCB
415 V	244-14AG-SBY	244-14LG-SBB	244-14DG-SBB
440 V	244-14AG-SHY	244-14LG-SHB	244-14DG-SHB
480 V	244-14AG-SEY	244-14LG-SEB	244-14DG-SEB

For the 244-14L and 244-14D models, the generator voltage is compared to the nominal input (bus) voltage specified at time of ordering. For the 244-14G and 244-14H models, the generator voltage is compared to the measured bus voltage.

CONNECTIONS

360° LED synchroscope

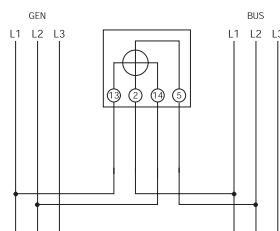

360° LED synchroscope and synchro check relay

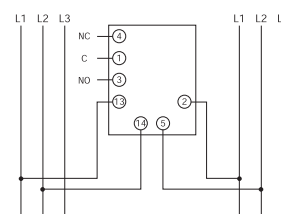

Synchroscope

FEATURES

- Typically used to measure between Busbar and Generator
- Available as LED indicator only, LED indicator with LCD display, LED indicator with synchro check relay, LED indicator with LCD display and synchro check relay



APPLICATIONS

- Used on manual and semi-automatic synchronising applications
- AC switchgears, panels and distribution boards
- Generator sets

CONSTRUCTION

- Instruments are microprocessor based
- Slot in screw fixing

STANDARDS

- CE marked



BENEFITS

- Supports damage prevention on expensive assets
- Simple synchronisation conditions setting
- High visibility
- Terminal cover included
- Low self consumption
- Up to five meters in one unit

GENERAL SPECIFICATION

Synchronizing functions	
Voltage difference setting (ΔU)	1.5
Accuracy	+/- 2.5%
Phase difference setting	2 ... 20° el.
Accuracy	+/- 3° el.
Time delay synchronization	0.1 ... 1 s.
Accuracy	+/- 10%
Synchronization pulse duration	300 ms
Accuracy	+/- 30 ms
Nominal frequency range	45/65 Hz
Output relay specification	250 V, 6A, 50 Hz, 1500 VA
Voltage burden	<4 VA
Overload	1.2 x Un permanently, 2 x Un for 3s
LED functions	
Resolution $\Delta \varphi$ display	20° el.
Magnified resolution range	+/- 15° el.
Magnified resolution	5° el.
Accuracy at $\Delta \varphi = 0$	+/- 3° el.
LCD functions	
Accuracy voltage display	+/- 1.5%
Accuracy frequency display	+/- 0.5%
Phase difference accuracy Ugen to Ubb	+/- 3° el.

PRODUCT CODES

Bezel size (mm)	96	96	96
	M244-14A-S LED only	M244-14L-S LED & synchro check relay	M244-14D-S LED & synchro check relay with deadbus option
Bezel size (mm)	96	96	96
		M244-14M-S LED & synchro check relay & LCD	M244-14E-S LED & synchro check relay with deadbus option & LCD display

Standard input ranges

Voltage	100 V L/L, 110 V L/L, 400 V L/L, 415 V L/L, 440 V L/L
---------	---

CONNECTION DIAGRAMS

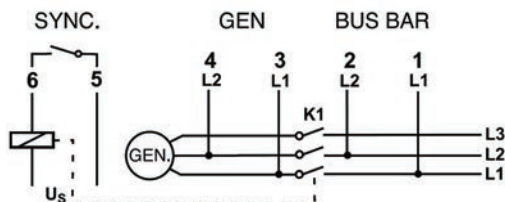

ORDER DATA/EXAMPLES

- 1) Select type: M244-14M-S,
- 2) Specify input voltage: 415 V,
- 3) Specify display or output:
Relay output,
- 4) Specify frequency: 45-65 Hz,
- 5) Specify functional description:
Output duration 300ms

Power wattmeters

FEATURES

- Indicates active power of electrical systems
- Several voltage ranges available
- Current connection via "through hole" CT on the instrument

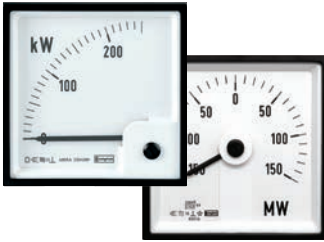

APPLICATIONS

- AC switchgears, panels and distribution boards
- Control boards
- Generator sets

CONSTRUCTION

- Instruments operate on a fast sampling method of input quantities (current and voltage) of the connected phases
- Meters include "through hole" CT connection, voltage dividers, internal microprocessor and power supply unit
- Slot in screw fixing

APPROVALS

- CE marked



- Accuracy class - 1.5
- Maximum continuous overload - $3 \times I_n$, $1.5 \times U_n$
- Maximum short duration overload - $25 \times I_n$ for 30 seconds, $50 \times I_n$ for 1 second, $2 \times U_n$ for 10 seconds
- Voltage burden - $<0.1 \text{ VA}$ per phase
- Current burden - $<0.1 \text{ VA}$ per phase
- Frequency - 50/60 Hz

BENEFITS

- Easy to operate
- High visibility
- Terminal cover included
- Low self consumption
- Internal power supply from voltage input

PRODUCT CODES

Bezel size (mm)	96	96	96	96	96
Scale length (mm)	95	95	95	95	95
Wattmeter 90°	M244-210 single-phase	M244-211 3P/3W balanced	M244-21C 3P/4W balanced	M244-213 3P/3W unbalanced	M244-214 3P/4W unbalanced
Bezel size (mm)	96	96	96	96	96
Scale Length (mm)	135	135	135	135	135
Wattmeter 240°	M244-215 single-phase	M244-216 3P/3W balanced	M244-21D 3P/4W balanced	M244-218 3P/3W unbalanced	M244-219 3P/4W unbalanced
Standard input ranges					
Single-phase, 3P/4W balanced, 3P/4W unbalanced	57.7 V L-N/1A, 57.7 V L-N/5A, 63.5 V L-N/1A, 63.5 V L-N/5 A, 230 V L-N/1 A, 230 V L-N/5 A, 240 V -N/1 A, 240 V L-N/5 A, 254 V L-N/1 A, 254 V L-N/5 A,				
3P/3W balanced, 3P/3W unbalanced	100 V L-L/1 A, 100 V L-L/5 A, 110 V L-L/1 A, 110 V L-L/5 A, 400 V L-L/1 A, 400 V L-L/5 A, 415 V L-L/1 A, 415 V L-L/5 A, 440 V L-L/1 A, 440 V L-L/5 A				

CALCULATION OF END SCALE VALUE

End scale value is calculated using the formula below, where correct voltage must be selected (either L-N or L-L), depending on the electrical system and the type of meter used. Scale factor, e.g. the relation between end scale value and nominal apparent power ($\cos\phi = 1$) must be between 0.6 to 1.2. It is recommended selecting the scale value from 1 - 1.2 - 1.25 - 1.5 - 2 - 2.5 - 3 - 4 - 5 - 6 - 7.5 - 8 (and their decades) closest to the calculated result.

Electrical system	Formula	Example	End scale value to choose (considering 0,6 to 1.2 x S)
Single-phase, direct voltage connection	$P = U(L-N) \times I_p \times \cos$	$P = 230 \text{ V} \times 50 \text{ A} \times 0.9 = 10350 \text{ W} = 10.35 \text{ kW}$	10 kW
3-phase 4-wire, direct voltage connection (balanced or unbalanced)	$P = 3 \times U(L-N) \times I_p \times \cos$	$P = 3 \times 230 \text{ V} \times 400 \text{ A} \times 0.95 = 262200 \text{ W} = 262,2 \text{ kW}$	250 kW
3-phase 3-wire, direct voltage connection (balanced or unbalanced)	$P = 1.732 \times U(L-L) \times I_p \times \cos$	$P = 1.732 \times 400 \text{ V} \times 1000 \text{ A} \times 0.9 = 623520 \text{ W} = 623,52 \text{ kW}$	600 kW
3-phase 4-wire, voltage connection via VT (balanced or unbalanced)	$P = 3 \times U_p(L-N) \times I_p \times \cos$	$P = 3 \times 5770 \text{ V} \times 100 \text{ A} \times 0.95 = 1644450 \text{ W} = 1,64445 \text{ MW}$	1.5 MW
3-phase 3-wire, voltage connection via VT (balanced or unbalanced)	$P = 1.732 \times U_p(L-L) \times I_p \times \cos$	$P = 1.732 \times 30000 \text{ V} \times 50 \text{ A} \times 0.9 = 2338200 \text{ W} = 2,3382 \text{ MW}$	2.5 MW

ORDER DATA/EXAMPLES

SINGLE-PHASE

- 1) Select type: M244-210,
- 2) Specify input voltage and CT ratio: 230 V L-N, 50/5 A,
- 3) Specify scaling: 0 - 10 kW,
- 4) Specify frequency: 50/60 Hz,

3-PHASE 4-WIRE BALANCED OR 3-PHASE 4-WIRE UNBALANCED

- 1) Select type: M244-21D,

- 2) Specify input voltage and CT ratio: 230 V L-N, 400/5 A,
- 3) Specify scaling: 0-250 kW,
- 4) Specify frequency: 50/60 Hz

3-PHASE 3-WIRE BALANCED OR UNBALANCED

- 1) Select type: M244-213,
- 2) Specify input voltage and CT ratio: 400 V L-L, 1000/1 A,

- 3) Specify scaling: 0 - 600 kW,
- 4) Specify frequency: 50/60 Hz

3-PHASE 4-WIRE BALANCED OR UNBALANCED, VT CONNECTED

- 1) Select type: M244-214,
- 2) Specify VT ratio and CT ratio: 5770/57.7 V L-N, 100/5 A,
- 3) Specify scaling: 0-1.5 MW,
- 4) Specify frequency: 50/60 Hz

3-PHASE 3-WIRE BALANCED OR UNBALANCED

- 1) Select type: M244-218,
- 2) Specify input VT ratio and CT ratio: 30000/110 V L-L, 50/1 A,
- 3) Specify scaling: 0 - 2.5 MW
- 4) Specify frequency: 50/60 Hz

Power varmeters

FEATURES

- Indicates reactive power of electrical systems
- Several voltage ranges available
- Current connection via "through hole" CT on the instrument



APPLICATIONS

- AC switchgears, panels and distribution boards
- Control boards
- Generator sets

CONSTRUCTION

- Instruments operate on a fast sampling method of input quantities (current and voltage) of the connected phases.
- Meters include "through hole" CT connection, voltage dividers, internal microprocessor and power supply unit.
- Slot in screw fixing

APPROVALS

- CE marked



BENEFITS

- Easy to operate
- High visibility
- Terminal cover included
- Low self consumption
- Internal power supply from voltage input

GENERAL SPECIFICATION

Accuracy class	1.5
Maximum continuous overload	3 x In, 1.5 x Un
Maximum short duration overload	25 x In for 30 seconds, 50 x In for 1 second, 2 x Un for 10 seconds
Voltage burden	<0.1 VA per phase
Current burden	<0.1 VA per phase
Frequency	50/60 Hz

PRODUCT CODES

Bezel size (mm)	96	96	96	96	96
Scale Length (mm)	95	95	95	95	95
Varmeter 90°	M244-310 single-phase	M244-311 3P/3W balanced	M244-31C 3P/4W balanced	M244-313 3P/3W unbalanced	M244-314 3P/4W unbalanced
Bezel size (mm)	96	96	96	96	96
Scale length (mm)	135	135	135	135	135
Varmeter 240°	M244-315 single-phase	M244-316 3P/3W balanced	M244-31D 3P/4W balanced	M244-318 3P/3W unbalanced	M244-319 3P/4W unbalanced
Standard input ranges					
Single-phase, 3P/4W balanced, 3P/4W unbalanced	57.7 V L-N/1 A, 57.7 V L-N/5 A, 63.5 V L-N/1 A, 63.5 V L-N/5 A, 230 V L-N/1 A, 230 V L-N/5 A, 240 V L-N/1 A, 240 V L-N/5 A, 254 V L-N/1 A, 254 V L-N/5 A				
3P/3W balanced, 3P/3W unbalanced	100 V L-L/1 A, 100 V L-L/5 A, 110 V L-L/1 A, 110 V L-L/5 A, 400 V L-L/1 A, 400 V L-L/5 A, 415 V L-L/1 A, 415 V L-L/5 A, 440 V L-L/1 A, 440 V L-L/5 A				

CALCULATION OF END SCALE VALUE

End scale value is calculated using the formula below, where correct voltage must be selected (either L-N or L-L), depending on the electrical system and the type of meter used. Scale factor, e.g. the relation between end scale value and nominal apparent power ($\cos\phi = 1$) must be between 0.6 to 1.2. It is recommended selecting the scale value from 1 - 1.2 - 1.25 - 1.5 - 2 - 2.5 - 3 - 4 - 5 - 6 - 7.5 - 8 (and their decades) closest to the calculated result.

I_p = CT primary current, U_p = VT primary voltage, U = direct connected voltage, $\sin\phi$ = power factor

Electrical system	Formula	Example	End scale value to choose (considering 0,6 to 1.2 x S)
Single-phase, direct voltage connection	$Q = U(L-N) \times I_p \times \sin\phi$	$Q = 230V \times 50A \times 0.44 = 5060 \text{ var} = 5,06 \text{ kvar}$	6 kvar
3-phase 4-wire, direct voltage connection (balanced or unbalanced)	$Q = 3 \times U(L-N) \times I_p \times \sin$	$P = 3 \times 230V \times 400A \times 0.31 = 85560 \text{ var} = 85,56 \text{ kvar}$	200 kvar
3-phase 3-wire, direct voltage connection (balanced or unbalanced)	$Q = 1.732 \times U(L-L) \times I_p \times \sin$	$P = 1.732 \times 400V \times 1000A \times 0,44 = 304832 \text{ var} = 304,8 \text{ kvar}$	500 kvar
3-phase 4-wire, voltage connection via VT (balanced or unbalanced)	$Q = 3 \times U_p(L-N) \times I_p \times \sin$	$P = 3 \times 5770V \times 100A \times 0.199 = 344469 \text{ var} = 344,469 \text{ kvar}$	1 Mvar
3-phase 3-wire, voltage connection via VT (balanced or unbalanced)	$Q = 1.732 \times U_p(L-L) \times I_p \times \sin$	$P = 1.732 \times 30000V \times 50A \times 0,44 = 1143120 \text{ var} = 1,14312 \text{ Mvar}$	2 Mvar

ORDER DATA/EXAMPLES

SINGLE-PHASE

- 1) Select type: M244-310,
- 2) Specify input voltage and CT ratio: 230 V L-N, 50/5 A,
- 3) Specify scaling: 0 - 6 kvar,
- 4) Specify frequency: 50/60 Hz,

3-PHASE 4-WIRE BALANCED OR 3-PHASE 4-WIRE UNBALANCED

- 1) Select type: M244-31D,

- 2) Specify input voltage and CT ratio: 230 V L-N, 400/5 A,
- 3) Specify scaling: 0 - 200 kvar,
- 4) Specify frequency: 50/60 Hz

3-PHASE 3-WIRE BALANCED OR UNBALANCED

- 1) Select type: M244-313,
- 2) Specify input voltage and CT ratio: 400 V L-L, 1000/1 A,
- 3) Specify scaling: 0 - 500 kvar,
- 4) Specify frequency: 50/60 Hz

3-PHASE 4-WIRE BALANCED OR UNBALANCED, VT CONNECTED

- 1) Select type: M244-314,
- 2) Specify VT ratio and CT ratio: 5770/57.7 V L-N, 100/5 A,
- 3) Specify scaling: 0 - 1 Mvar,
- 4) Specify frequency: 50/60 Hz

3-PHASE 3-WIRE BALANCED OR UNBALANCED

- 1) Select type: M244-318,
- 2) Specify input VT ratio and CT ratio: 30000/110 V L-L, 50/1 A,
- 3) Specify scaling: 0 - 2 Mvar,
- 4) Specify frequency: 50/60 Hz

Wattmeters and varmeters wiring diagrams



WIRING DIAGRAMS OF WATTMETERS AND VARMETERS

Single-phase, direct or VT voltage connection

Wattmeter M244-210
Wattmeter M244-215
Varmeter M244-310
Varmeter M244-315

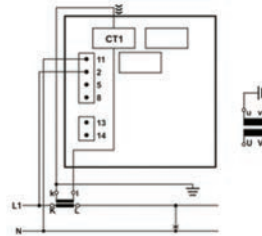

3-phase 3-wire balanced, direct or VT voltage connection

Wattmeter M244-211
Wattmeter M244-216
Varmeter M244-311
Varmeter M244-316

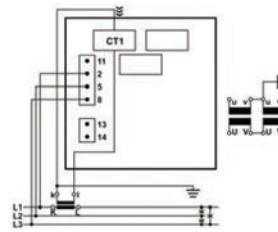

3-phase 4-wire balanced, direct or VT voltage connection

Wattmeter M244-21C
Wattmeter M244-21D
Varmeter M244-31C
Varmeter M244-31D

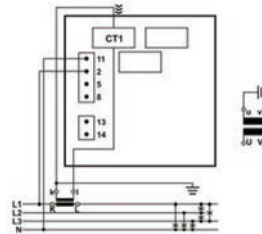

3-phase 3-wire unbalanced, direct or VT voltage connection

Wattmeter M244-213
Wattmeter M244-218
Varmeter M244-313
Varmeter M244-318

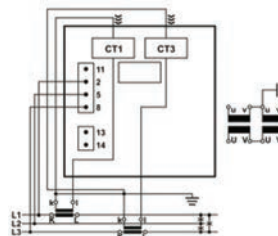

3-phase 4-wire unbalanced, direct or VT voltage connection

Wattmeter M244-214
Wattmeter M244-219
Varmeter M244-314
Varmeter M244-319

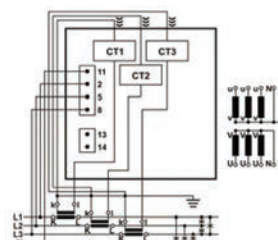

Active energy meter with power indicator

FEATURES

- Counts electrical active energy and indicates active power of electrical systems
- Several voltage ranges available
- Current connection via "through hole" CT on the instrument. No need to interrupt wiring from CT
- Pulsed output as standard

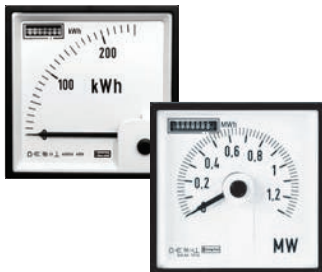

APPLICATIONS

- AC switchgears, panels and distribution boards
- Control boards
- Generator sets

CONSTRUCTION

- Instruments operate on a fast sampling method of input quantities (current and voltage) of the connected phases
- Meters include "through hole" CT connection, voltage dividers, internal microprocessor and power supply unit
- Slot in screw fixing

APPROVALS

- CE marked
- BV approved



BENEFITS

- High visibility
- Terminal cover included
- Low self consumption
- Separated power supply

GENERAL SPECIFICATION

Accuracy class active power meter	1.5
Accuracy class active energy meter	1 to EN 62053-21
Maximum continuous overload	2 x In, 1.2 x Un
Nominal frequency	50/60 Hz
Voltage burden	<0.1 VA per phase
Current burden	<0.1 VA per phase
Power supply	Various AC volts between 57.7 and 400
Frequency	40-65 Hz
Voltage burden	<3 VA
Pulsed output	1 SO pulsed output with 1p/10kWh, 1p/100kWh, 1p/10MWh, 1p/100MWh. Maximum pulse rate may not exceed 33 pulses per second (1980 pulses per minute). If in doubt choose next higher value, e.g. 1p/100kWh instead of 1p/10kWh

PRODUCT CODES

Bezel size (mm)	96	96	96	96	96
Scale length (mm)	95	95	95	95	95
Active energy meter with Wattmeter 90°	M244-HWG single-phase	M244-HWH 3P/3W balanced	M244-HWV 3P/4W balanced	M244-HWJ 3P/3W unbalanced	M244-HWK 3P/4W unbalanced
Bezel size (mm)	96	96	96	96	96
Scale Length (mm)	135	135	135	135	135
Active energy meter with Wattmeter 240°	M244-HWB single-phase	M244-HWC 3P/3W balanced	M244-HWU 3P/4W balanced	M244-HWD 3P/3W unbalanced	M244-HWE 3P/4W unbalanced
Standard input ranges					
Single-phase, 3P/4W balanced & unbalanced	57.7 V L-N/1 A, 57.7 V L-N/5 A, 63.5 V L-N/1 A, 63.5 V L-N/5 A, 230 V L-N/1 A, 230 V L-N/5 A, 240 V L-N/1 A, 240 V L-N/5 A, 254 V L-N/1 A, 254 V L-N/5 A,				
3P/3W balanced & unbalanced	1100 V L-L/1 A, 100 V L-L/5 A, 110 V L-L/1 A, 110 V L-L/5 A, 400 V L-L/1 A, 400 V L-L/5 A, 415 V L-L/1 A, 415 V L-L/5 A, 440 V L-L/1 A, 440 V L-L/5 A				

CALCULATION OF END SCALE VALUE

End scale value is calculated using the formula below, where correct voltage must be selected (either L-N or L-L), depending on the electrical system and the type of meter used. Scale factor, e.g. the relation between end scale value and nominal apparent power ($\cos\phi = 1$) must be between 0.6 to 1.2. It is recommended selecting the scale value from 1 - 1.2 - 1.25 - 1.5 - 2 - 2.5 - 3 - 4 - 5 - 6 - 7.5 - 8 (and their decades) closest to the calculated result.

I_p = CT primary current, U_p = VT primary voltage, U = direct connected voltage, $\cos\phi$ = power factor.

Electrical system	Formula	Example	End scale value to choose (considering 0,6 to 1.2 x S)
Single-phase, direct voltage connection	$P = U(L-N) \times I_p \times \cos$	$P = 230 \text{ V} \times 50 \text{ A} \times 0.9 = 10350 \text{ W} = 10.35 \text{ kW}$	10 kW
3-phase 4-wire, direct voltage connection (balanced or unbalanced)	$P = 3 \times U(L-N) \times I_p \times \cos$	$P = 3 \times 230 \text{ V} \times 400 \text{ A} \times 0.95 = 262200 \text{ W} = 262.2 \text{ kW}$	250 kW
3-phase 3-wire, direct voltage connection (balanced or unbalanced)	$P = 1.732 \times U(L-L) \times I_p \times \cos$	$P = 1.732 \times 400 \text{ V} \times 1000 \text{ A} \times 0.9 = 623520 \text{ W} = 623.52 \text{ kW}$	600 kW
3-phase 4-wire, voltage connection via VT (balanced or unbalanced)	$P = 3 \times U_p(L-N) \times I_p \times \cos$	$P = 3 \times 5770 \text{ V} \times 100 \text{ A} \times 0.95 = 1644450 \text{ W} = 1.64445 \text{ MW}$	1.5 MW
3-phase 3-wire, voltage connection via VT (balanced or unbalanced)	$P = 1.732 \times U_p(L-L) \times I_p \times \cos$	$P = 1.732 \times 30000 \text{ V} \times 50 \text{ A} \times 0.9 = 2338200 \text{ W} = 2.3382 \text{ MW}$	2.5 MW

Active energy meter with power indicator cont.

ORDER DATA/EXAMPLES SINGLE-PHASE

- 1) Select type: M244-HWG,
- 2) Specify input voltage and CT ratio: 230 V L-N, 50/5 A,
- 3) Spec. scaling: 0-10 kW,
- 4) Spec. frequency: 50/60 Hz,
- 5) Select pulse rate: 1p/10 kWh,
- 6) Select output: 1 pulsed output

3-PHASE 4-WIRE BALANCED OR 3-PHASE 4-WIRE UNBALANCED

- 1) Select type: M244-HWK,
- 2) Specify input voltage and CT ratio: 230 V L-N, 400/5 A,
- 3) Spec. scaling: 0-250 kW,
- 4) Spec. frequency: 50/60 Hz,
- 5) Select pulse rate: 1p/10 kWh,
- 6) Select output: 1 puls. o/p

3-PHASE 3-WIRE BALANCED OR 3-PHASE 4-WIRE UNBALANCED

- 1) Select type: M244-HWJ,
- 2) Specify input voltage and CT ratio: 400 V L-L, 1000/1 A,
- 3) Spec. scaling: 0-600 kW,
- 4) Spec. frequency: 50/60 Hz ,
- 5) Select pulse rate: 1p/10 kWh,
- 6) Select output: 1 puls. o/p

3-PHASE 4-WIRE BALANCED OR UNBALANCED, VT CONNECTED

- 1) Select type: M244-HWU,
- 2) Specify VT ratio and CT ratio: 5770/57.7 V L-N, 100/5 A,
- 3) Spec. scaling: 0-1.5 MW,
- 4) Spec. frequency: 50/60 Hz,
- 5) Select pulse rate: 1p/100 kWh,
- 6) Select output: 1 pulsed output

3-PHASE 3-WIRE BALANCED OR UNBALANCED

- 1) Select type: M244-HWD,
- 2) Specify input VT ratio and CT ratio: 30000/110 V L-L, 50/1 A,
- 3) Spec. scaling: 0-2.5 MW
- 4) Spec. frequency: 50/60 Hz,
- 5) Select pulse rate: 1p/100 kWh,
- 6) Select output: 1 pulsed output

Reactive energy meter with power indicator

FEATURES

- Counts electrical reactive energy and indicates reactive power of electrical systems
- Several voltage ranges available
- Current connection via "through hole" CT on the instrument. No need to interrupt wiring from CT
- Pulsed output as standard



APPROVALS

- CE marked
- BV approved



BENEFITS

- High visibility
- Terminal cover included
- Low self consumption
- Separated power supply

GENERAL SPECIFICATION

Accuracy class reactive power meter	1.5
Accuracy class reactive energy meter	2 to EN 62053-23
Maximum continuous overload	2 x In, 1.2 x Un
Nominal frequency	50/60 Hz
Voltage burden	<0.1 VA per phase
Current burden	<0.1V A per phase
Power supply	Various AC volts between 57.7 and 400
Frequency	40-65 Hz
Voltage burden	<3 VA
Pulsed output	1 SO pulsed output with 1p/10 kWh, 1p/100 kWh, 1p/10 MWh, 1p/100 MWh. Maximum pulse rate may not exceed 33 pulses per second (1980 pulses per minute). If in doubt choose next higher value, e.g. 1p/100/ kWh instead of 1p/10 kWh

Reactive energy meter with power indicator cont.

APPLICATIONS

- AC switchgears, panels and distribution boards
- Control boards
- Generator sets

CONSTRUCTION

- Instruments operate on a fast sampling method of input quantities (current and voltage) of the connected phases
- Meters include "through hole" CT connection, voltage dividers, internal microprocessor and power supply unit
- Slot in screw fixing

PRODUCT CODES

Bezel size (mm)	96	96	96	96	96
Scale length (mm)	95	95	95	95	95
Reactive energy meter with Varmeter 90°	M244-HXG single-phase	M244-HXH 3P/3W balanced	M244-HXV 3P/4W balanced	M244-HXJ 3P/3W unbalanced	M244-HXK 3P/4W unbalanced
Bezel size (mm)	96	96	96	96	96
Scale Length (mm)	135	135	135	135	135
Reactive energy meter with Varmeter 240°	M244-HXB single-phase	M244-HXC 3P/3W balanced	M244-HXU 3P/4W balanced	M244-HXD 3P/3W unbalanced	M244-HXE 3P/4W unbalanced
Standard input ranges					
Single-phase, 3P/4W balanced & unbalanced	57.7 V L-N/1 A, 57.7 V L-N/5 A, 63.5 V L-N/1 A, 63.5 V L-N/5 A, 230 V L-N/1 A, 230 V L-N/5 A, 240 V L-N/1 A, 240 V L-N/5 A, 254 V L-N/1 A, 254 V L-N/5 A,				
3P/3W balanced & unbalanced	100 V L-L/1 A, 100 V L-L/5 A, 110 V L-L/1 A, 110 V L-L/5 A, 400 V L-L/1 A, 400 V L-L/5 A, 415 V L-L/1 A, 415 V L-L/5 A, 440 V L-L/1 A, 440 V L-L/5 A				

CALCULATION OF END SCALE VALUE

End scale value is calculated using the formula below, where correct voltage must be selected (either L-N or L-L), depending on the electrical system and the type of meter used. Scale factor, e.g. the relation between end scale value and nominal apparent power ($\cos\phi = 1$) must be between 0.6 to 1.2. It is recommended selecting the scale value from 1 - 1.2 - 1.25 - 1.5 - 2 - 2.5 - 3 - 4 - 5 - 6 - 7.5 - 8 (and their decades) closest to the calculated result.

I_p = CT primary current, U_p = VT primary voltage, U = direct connected voltage, $\sin \phi$ = power factor.

Electrical system	Formula	Example	End scale value to choose (considering 0.6 to 1.2 x S)
Single-phase, direct voltage connection	$P = U(L-N) \times I_p \times \sin$	$Q = 230 \text{ V} \times 50 \text{ A} \times 0.44 = 5060 \text{ var} = 5.06 \text{ kvar}$	6 kvar
3-phase 4-wire, direct voltage connection (balanced or unbalanced)	$P = 3 \times U(L-N) \times I_p \times \sin \phi$	$P = 3 \times 230 \text{ V} \times 40 \text{ A} \times 0.31 = 85560 \text{ var} = 85.56 \text{ kvar}$	200 kvar
3-phase 3-wire, direct voltage connection (balanced or unbalanced)	$P = 1.732 \times U(L-L) \times I_p \times \sin$	$P = 1.732 \times 400 \text{ V} \times 1000 \text{ A} \times 0.44 = 304832 \text{ var} = 304.8 \text{ kvar}$	500 kvar
3-phase 4-wire, voltage connection via VT (balanced or unbalanced)	$P = 3 \times U_p(L-N) \times I_p \times \sin$	$P = 3 \times 5770 \text{ V} \times 100 \text{ A} \times 0.199 = 344469 \text{ var} = 344.469 \text{ kvar}$	1 Mvar
3-phase 3-wire, voltage connection via VT (balanced or unbalanced)	$P = 1.732 \times U_p(L-L) \times I_p \times \sin$	$P = 1.732 \times 30000 \text{ V} \times 50 \text{ A} \times 0.44 = 1143120 \text{ var} = 1.14312 \text{ Mvar}$	2 Mvar

ORDER DATA/EXAMPLES

SINGLE-PHASE

- 1) Select type: M244-HXG,
- 2) Specify input voltage and CT ratio: 230 V L-N, 50/5 A,
- 3) Spec. scaling: 0-6 kvar,
- 4) Spec. frequency: 50/60 Hz,
- 5) Select pulse rate: 1p/10 kvarh,
- 6) Select output: 1 pulsed output

3-PHASE 4-WIRE BALANCED OR 3-PHASE 4-WIRE UNBALANCED

- 1) Select type: M244-HXK,
- 2) Specify input voltage and CT ratio: 230 V L-N, 400/5 A,
- 3) Spec. scaling: 0-200 kvar,
- 4) Spec. frequency: 50/60 Hz,
- 5) Select pulse rate: 1p/10 kvarh,
- 6) Select output: 1 pul. O/P

3-PHASE 3-WIRE BALANCED OR UNBALANCED

- 1) Select type: M244-HXJ,
- 2) Spec. input voltage and CT ratio: 400 V L-L, 1000/1 A,
- 3) Spec. scaling: 0-500 kvar,
- 4) Spec. frequency: 50/60 Hz,
- 5) Select pulse rate: 1p/10 kvarh,
- 6) Select output: 1 pul. O/P

3-PHASE 4-WIRE BALANCED OR UNBALANCED, VT CONNECTED

- 1) Select type: M244-HXU,
- 2) Specify VT ratio and CT ratio: 5770/57.7 V L-N, 100/5 A,
- 3) Spec. scaling: 0-1 M var,
- 4) Spec. frequency: 50/60 Hz,
- 5) Select pulse rate: 1p/100 kvarh,
- 6) Select output: 1 pul. O/P

3-PHASE 3-WIRE BALANCED OR UNBALANCED

- 1) Select type: M244-HXD,
- 2) Specify input VT ratio and CT ratio: 30000/110 V L-L, 50/1 A,
- 3) Spec. scaling: 0-2 Mvar
- 4) Spec. frequency: 50/60 Hz,
- 5) Select pulse rate: 1p/100 kWh,
- 6) Select output: 1 pulsed O/P

Active and reactive energy meter with power indicator wiring diagrams

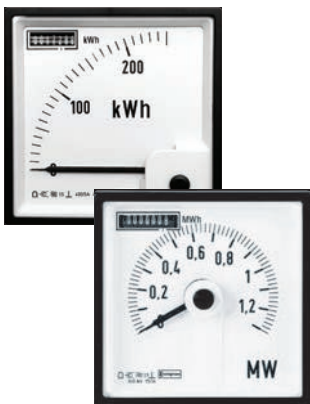

WIRING DIAGRAMS ENERGY METERS

Single-phase, direct or VT voltage connection

Active Energy Meter M244-HWG
 Active Energy Meter M244-HWB
 Reactive Energy Meter M244-HXG
 Reactive Energy Meter M244-HXB

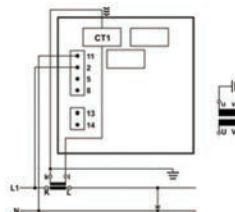

Power supply:
 Terminal 13 and 14
 Pulsed output:
 Terminal 15 and 16

3-phase 3-wire balanced, direct or VT voltage connection

Active Energy Meter M244-HWH
 Active Energy Meter M244-HWC
 Reactive Energy Meter M244-HXH
 Reactive Energy Meter M244-HXC

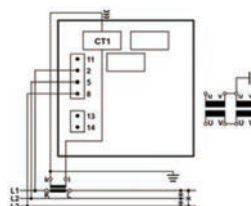

Power supply:
 Terminal 13 and 14
 Pulsed output:
 Terminal 15 and 16

3-phase 4-wire balanced, direct or VT voltage connection

Active Energy Meter M244-HWV
 Active Energy Meter M244-HWU
 Reactive Energy Meter M244-HXV
 Reactive Energy Meter M244-HXU

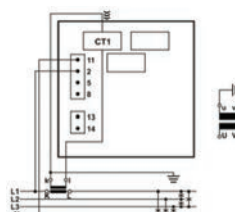

Power supply:
 Terminal 13 and 14
 Pulsed output:
 Terminal 15 and 16

3-phase 3-wire unbalanced, direct or VT voltage connection

Active Energy Meter M244-HWJ
 Active Energy Meter M244-HWD
 Reactive Energy Meter M244-HXJ
 Reactive Energy Meter M244-HXD

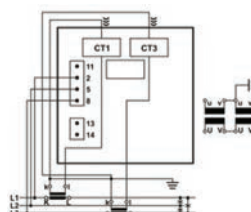

Power supply:
 Terminal 13 and 14
 Pulsed output:
 Terminal 15 and 16

3-phase 4-wire unbalanced, direct or VT voltage connection

Active Energy Meter M244-HWK
 Active Energy Meter M244-HWE
 Reactive Energy Meter M244-HXK
 Reactive Energy Meter M244-HXE

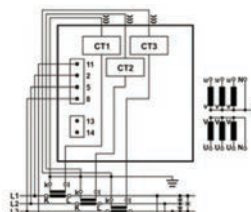

Power supply:
 Terminal 13 and 14
 Pulsed output:
 Terminal 15 and 16

Long scale tap position indicators

FEATURES

- Monitoring of transformer tap position, hoist or valve position
- 3 wire system
- 21 position using 10Ω to 400Ω steps
- Moving coil indicator
- Stabilized power supply and transducer
- CE Approved



APPLICATIONS

- Monitor transformer tap position, hoist or valve position

BENEFITS

- Interchangeable dial
- Resistant to mechanical vibrations and shocks
 - Protective cover for terminal
 - Linear scale

PRODUCT CODES

Model	Function
M244-45P	96 DIN tap position indicator
M246-45P	144 DIN tap position indicator

SPECIFICATIONS

Accuracy	
Class	1.5
Measuring	
Auxiliary supply	110-220 V ±15% AC/DC
Bridge system	10Ω to 400Ω per step
Environmental	
Operating temperature	25 to 55 °C
Storage temperature	-40 to 70 °C
Relative humidity	≤ 80 % yearly average, no condensation
Enclosure	
Material	Flame retardant plastic (UL94V-0)
Enclosure protection	IP 52 (IP 00 for connection terminals, IP 20 connection terminals with protection)
Mounting	Fixing element to panel
Weight	0.2 kg
Safety	
Voltage	2 kV rms EN61010-1

Note: The remote potentiometer or resistance thermometer sensor to be supplied by the customer. Consult factory for custom positions and steps.

Long scale tap position indicators

CONNECTION DIAGRAMS

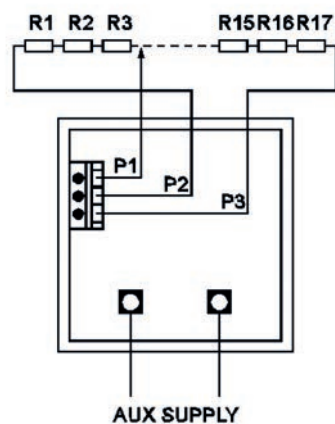

DIMENSIONS

Description	M244	M246
Bezel (mm)	96	144
Panel cut out (mm)	92 (+0.8)	138 (+1.0)
Bezel height (mm)	5.5	8.0
Terminal over (mm)	90	90

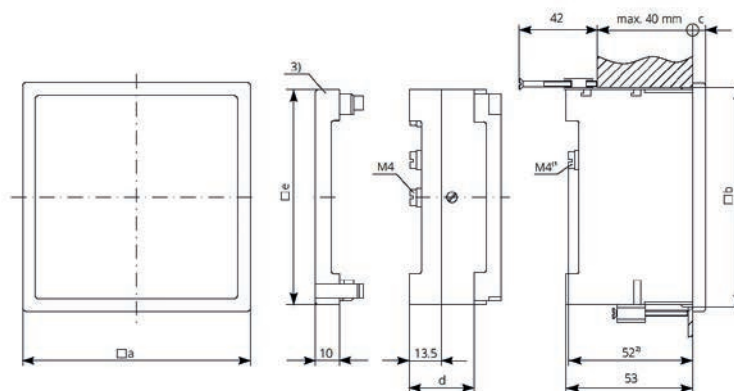





Chapter 2

Saxon series panel indicators

Saxon series panel indicators.....	36
AC ammeter.....	37
AC voltmeter.....	37
Milliammeters.....	37
DC voltmeter.....	38
DC ammeter.....	38
Frequency meter.....	38
Elapsed time meter.....	39

Saxon series panel indicators

FEATURES

- Three compact case sizes
- Withstands high levels of shock, vibration, dirt and humidity
- Pivot and jewel mechanisms



APPLICATIONS

- Switchgear
- Distribution systems
- Generator sets
- Control panels
- Energy management
- Building management
- Utility power monitoring
- Process control
- Motor control

APPROVALS

- UL approved file no. E203000
- CSA



BENEFITS

- Complies with ANSI C39.1 (IEC 51)
- IP54 (NEMA 3) protection
- Instruments comply with BS EN61010-1 and meet IEC414 (BS5458)
- Pass dielectric test (2600 V for 1min)

A range of 2½", 3½" and 4½" surface mount panel meters utilising pivot and jewel mechanisms and offering IP54 protection. The range includes iron vane and moving coil AC and DC ammeters and voltmeters and frequency meters designed to perform in demanding environments.

SPECIFICATIONS - FREQUENCY METERS

Accuracy	0.15 = 60 Hz, 1.25 = 400 Hz, 0.15 = 50 Hz, 0.25 = 55 Hz
Voltage	110/130 V, 200/250 V
Frequency	50 Hz or 60 Hz
Burden	4 VA Maximum

SPECIFICATIONS - MOVING IRON AC AMMETER AND VOLTMETER

Accuracy	±1.5%
Rating	Ammeters: 1 - 30 A Voltmeters: 50 V - 600 V
Overload	Ammeters: x1.2 continuous, x10 for 5 seconds Voltmeters: x1.2 continuous, x2 for 5 seconds
Burden	Ammeters: 0.5 VA Voltmeters: 4.5 VA maximum

SPECIFICATIONS - MOVING COIL DC AMMETER AND VOLTMETER

Accuracy	±1.5%
Rating	Ammeters: 1 - 30 A Voltmeters: 10 V - 600 V
Operating temperature	-20°C to +60°C (-4°F to +140°F)
Storage temperature	-30°C to +70°C (-22°F to +158°F)

DIMENSIONS

Specify number of fixing studs when ordering 2½" and 3½" meters. 4½" meters are supplied with 4 fixing studs.

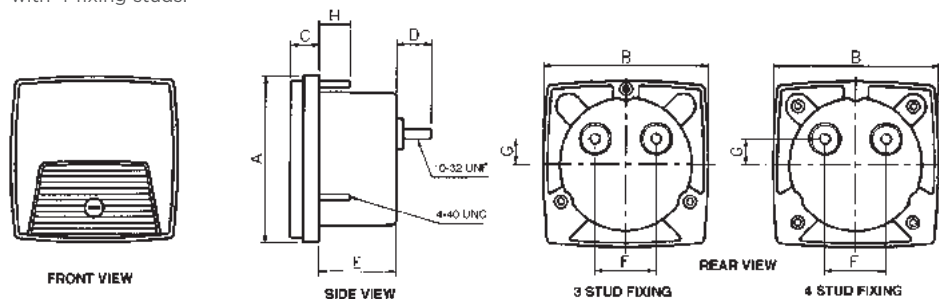

AC ammeter



PRODUCT CODES - AC AMMETER TRUE RMS READING (ACCURACY $\pm 2\%$ ES)

Rating	Scaling	Cat. no.
5 A	0-5 A	(01*)-75AA-LSLS-C7-B*
10 A	0-10 A	(01*)-75AA-MTMT-C7-B*
15 A	0-15 A	(01*)-75AA-NDND-C7-B*
20 A	0-20 A	(01*)-75AA-NGNG-C7-B*
30 A	0-30 A	(01*)-75AA-NLNL-C7-B*
1 A	Transformer rated	(01*)-75AA-LA**-C7-B*
5 A	Transformer rated	(01*)-75AA-LS**-C7-B*

AC voltmeter



PRODUCT CODES - AC VOLTMETER TRUE RMS READING (ACCURACY $\pm 2\%$ ES)

Rating	Scaling	Cat. no.
150 V	0-150 V	(01*)-75VA-PZPZ-C7-B*
300 V	0-300 V	(01*)-75VA-RXRX-C7-B*
600 V	0-600 V	(01*)-75VA-SJSJ-C7-B*
150 V	Transformer rated	(01*)-75VA-PZ**-C7-B*

Milliammeters



PRODUCT CODES - MILLIAMMETERS SUPPRESSED ZERO (ACCURACY $\pm 2\%$ ES)

Rating	Scaling	Cat. no.
4-20 mA	To suit requirements	(01*)-01RA-HG**-B*
		**Specify scale value

DC voltmeter



PRODUCT CODES - DC VOLTMETERS SENSITIVITY 1000Ω/VOLT (ACCURACY ±2% ES)

Rating	Scaling	Cat. no.
0-15 V	0-15 V	(01*)-01VA-NDND-B*
0-30 V	0-30 V	(01*)-01VA-NLNL-B*
0-50 V	0-50 V	(01*)-01VA-NTNT-B*
0-150 V	0-150 V	(01*)-01VA-PZPZ-B*
0-300 V	0-300 V	(01*)-01VA-RXRJ-B*
0-600 V	0-600 V	(01*)-01VA-SJSJ-B*

DC ammeter



PRODUCT CODES - DC AMMETER (ACCURACY ±2% ES)

Rating	Scaling	Cat. no.
0-1 mA	To suit requirements	(01*)-01AA-FA** -B*
0-5 mA	0-5 mA	(01*)-01AA-FXFX-B*
0-10 mA	0-10 mA	(01*)-01AA-GZGZ-B*
0-20 mA	0-20 mA	(01*)-01AA-HFHF-B*
0-50 mA	0-50 mA	(01*)-01AA-HYHY-B*
0-100 mA	0-100 mA	(01*)-01AA-JRJR-B*
0-200 mA	0-200 mA	(01*)-01AA-KAKA-B*
0-500 mA	0-500 mA	(01*)-01AA-KMKM-B*
0-1 A 0-1 A	(01*)-01AA-LALA-B*	
0-2 A 0-2 A	(01*)-01AA-LELE-B*	
0-5 A 0-5 A	(01*)-01AA-LSLS-B*	
0-10 A	0-10 A	(01*)-01AA-MTMT-B*
0-50 mV	To suit	(01*)-01AA-EC** -B*

Frequency meter



PRODUCT CODES - FREQUENCY METERS 120V, SELF CONTAINED

Rating	Scaling	Cat. no.
50 Hz	45-55 Hz	(01*)-41SA-PNAG-AG-B*
55 Hz	45-65 Hz	(01*)-41SA-PNAJ-AJ-B*
60 Hz	55-65 Hz	(01*)-41SA-PNAN-AN-B*

Elapsed time meter



PRODUCT CODES – ELAPSED TIME METERS 99999.99 HOURS, NON-RESETTABLE

Rating	Scaling	Cat. no.
110/130 V, 50 Hz	-	(01*)-155A-PNZH-C5-B*
200/250 V, 50 Hz	-	(01*)-155A-RNZH-C5-B*
480 V, 50 Hz	-	(01*)-155A-SEZH-C5-B*
110/130 V, 60 Hz	-	(01*)-156A-PNZH-C6-B*
200/250 V, 60 Hz	-	(01*)-156A-RNZH-C6-B*
480 V, 60 Hz	-	(01*)-156A-SEZH-C6-B*

To denote the required case size, replace the 01* in the catalogue number with 012, 013 or 014 for 2½", 3½" or 4½" respectively.

To denote the required stud fixing configuration, replace B* with B2 (2 stud), B3 (3 stud) or B4 (4 stud).

PANEL CUT-OUT

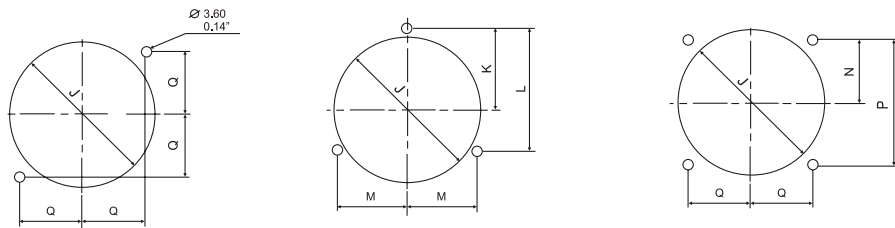

	A	B	C	D	E	F	G	H	J	K	L	M	N	P	Q
2½"	68.6	68.6	11.8	14.6	32.0	25.4	10.4	12.7	55.9	31.0	46.5	26.9	23.9	47.8	23.9
mm	2.70	2.70	0.46	0.57	1.26	1.00	0.41	0.50	2.20	1.22	1.83	1.06	0.94	1.88	0.94
inch															
3½"	88.9	88.9	11.8	14.6	36.0	25.4	10.4	12.7	69.9	40.2	60.3	34.8	28.5	57.0	28.5
mm	3.5	3.5	0.46	0.57	1.42	1.00	0.41	0.50	2.75	1.58	2.37	1.37	1.12	2.24	1.12
inch															
4½"	112.0	123.2	12.7	16.3	30.5	28.4	0.38	12.7	70.9				51.6	90.4	50.8
mm	4.41	4.85	0.50	0.64	1.20	1.12	0.41	0.50	2.78				2.03	3.56	2.00
inch															

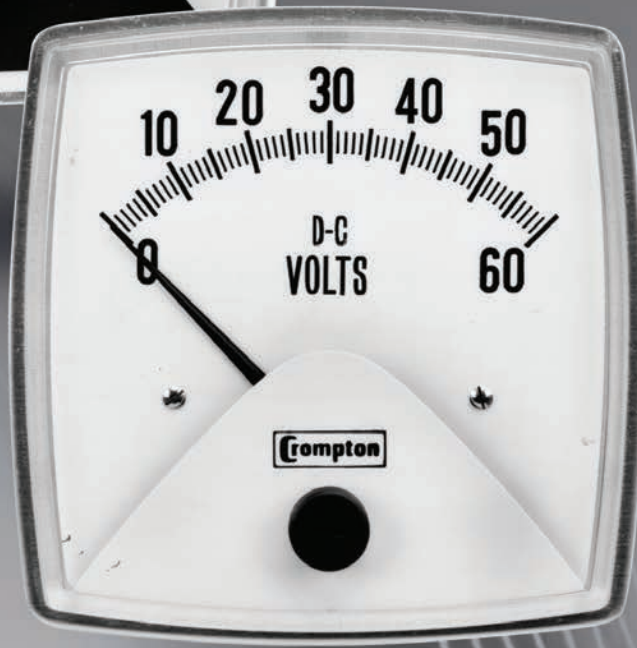
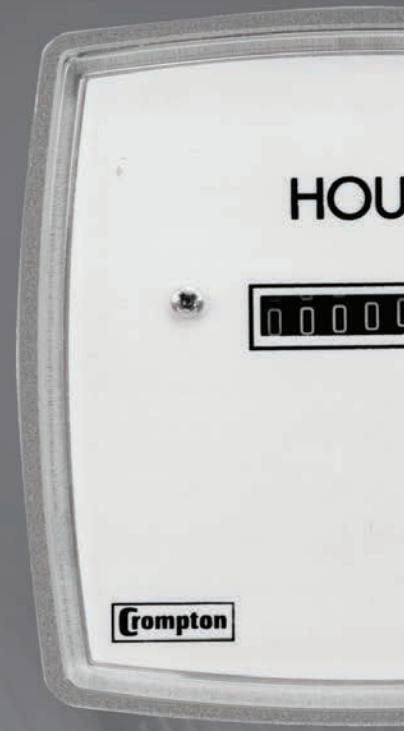



Chapter 3 016 series fiesta panel indicators

016 series fiesta panel indicators.....	42
AC ammeter short-scale.....	43
AC overload ammeter.....	43
AC voltmeter.....	43
DC ammeter.....	44
DC voltmeter.....	44
Frequency meter.....	44
Elapsed time meter.....	45
Transducer indicators.....	45

O16 series fiesta panel indicators



A robust range of short-scale 3 1/2" surface mount panel meters offering IP55 protection and featuring a wide view contoured window. The Fiesta range includes iron vane and moving coil AC and DC ammeters and voltmeters, elapsed time and frequency meters and is ideally suited for demanding environments. Options include panel gasket.

SPECIFICATIONS - IRON VANE AC AMMETER AND VOLTMETER

Accuracy	Ammeters 2%
Ratings	Short-scale 1 - 80 A
Voltmeters	50 V - 600 V
Overload	Ammeters: x1.2 continuous, 10 x for 5 seconds
Voltmeters	x1.2 for 2 hours, 2 x for 5 seconds
Burden	Ammeters: 0.5 VA; 1.5 VA
Voltmeters	4.5 VA maximum
Operating temperature	-20°C to +65°C (-4°F to +149°F)
Storage temperature	-30°C to +70°C (-22°F to +158°F)

SPECIFICATIONS - MOVING COIL DC AMMETER AND VOLTMETER

Accuracy	1.5
Ratings	Ammeters: 100 µA to 30 A
Voltmeters	50 mV - 600 V
Overload	Ammeters: x1.2 continuous, 10 x for 5 seconds
Voltmeters	x1.2 continuous, 2 x for 5 seconds
Impedance	Voltmeters: 1000 ohms per nominal volt
Operating temperature	-20°C to +65°C (-4°F to +149°F)
Storage temperature	-30°C to +70°C (-22°F to +158°F)

SPECIFICATIONS - ELAPSED TIME METER AND FREQUENCY METERS

Voltage	100/125 V, 200/250 V or 480 V AC
Frequency	50 Hz or 60 Hz
Burden	4 VA maximum
Operating temperature	-20°C to +65°C (-4°F to +149°F)
Storage temperature	-30°C to +70°C (-22°F to +158°F)

DIMENSIONS

Instrument	Dim X inches	Dim X mm
MC. INSTS	1/4"-28 UNF	18.0
MI voltmeter and AMM up to 59 A	1/4"-28 UNF	18.0
MI ammeter 60 A and over	5/16"-24 UNF	23.0

CONNECTIONS

Ammeter DC
direct connected
(max rating 30 A)

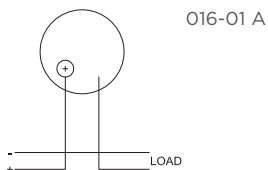

Ammeter AC

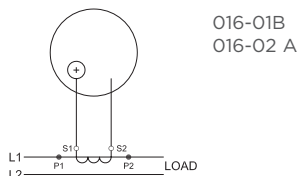

Voltmeter DC
direct connected
(max rating 800 A)

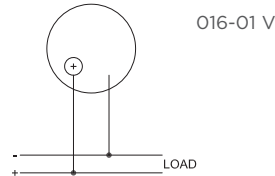

Voltmeter AC/
frequency meter
V.T. Operated

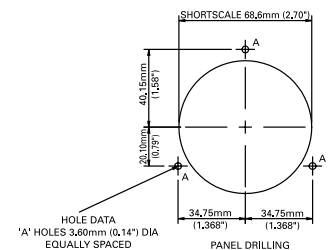
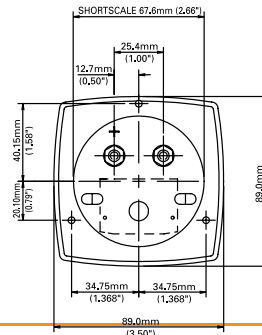
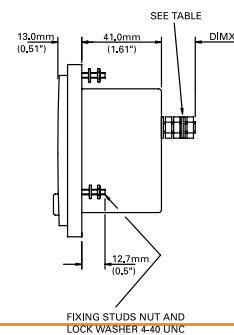
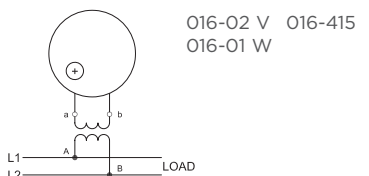

AC ammeter short-scale



PRODUCT CODES - TRUE RMS READING, SELF CONTAINED 50/60 HZ

Rating	Scaling	Cat. no.
5 A	0-5 A	•016-02A*-LSLS-C7
10 A	0-10 A	•016-02A*-MTMT-C7
15 A	0-15 A	•016-02A*-NDND-C7
20 A	0-20 A	•016-02A*-NGNG-C7
30 A	0-30 A	•016-02A*-NLNL-C7
5 A	Transformer rated	•016-02A*-LS** -C7

PRODUCT CODES - MOVING COIL RECTIFIED

1mA - 1 A	To suit	•016-01B*-
-----------	---------	------------

AC overload ammeter



PRODUCT CODES - TRUE RMS READING, SELF CONTAINED 50/60 HZ

Rating	Scaling	Cat. no.
5 A	0-5-30 A	•016-022*-LSLS-C7
10 A	0-10-60 A	•016-022*-MTMT-C7
15 A	0-15-90 A	•016-022*-NDND-C7
20 A	0-20-120 A	•016-022*-NGNG-C7
30 A	0-30-180 A	•016-022*-NLNL-C7
5 A	Transformer rated	•016-022*-LS** -C7

Rating	Scaling	Cat. no.
5 A	0-5-30 A	•016-023*-LSLS-C7
10 A	0-10-60 A	•016-023*-MTMT-C7
15 A	0-15-90 A	•016-023*-NDND-C7
20 A	0-20-120 A	•016-023*-NGNG-C7
30 A	0-30-180 A	•016-023*-NLNL-C7
5 A	Transformer rated	•016-023*-LS** -C7

Rating	Scaling	Cat. no.
5 A	0-5-30 A	•016-026*-LSLS-C7
10 A	0-10-60 A	•016-026*-MTMT-C7
15 A	0-15-90 A	•016-026*-NDND-C7
20 A	0-20-120 A	•016-026*-NGNG-C7
30 A	0-30-180 A	•016-026*-NLNL-C7
5 A	Transformer rated	•016-026*-LS** -C7

AC voltmeter



PRODUCT CODES - TRUE RMS READING

Rating	Scaling	Cat. no.
150V	0-150V	•016-02V*-PZPZ-C7
300V	0-300V	•016-02V*-RXRX-C7
600V	0-600V	•016-02V*-SJSJ-C7
150V	Transformer rated	•016-02V*-PZ** -C7

PRODUCT CODES - MOVING COIL RECTIFIED

50-600 V	To suit	•016-01W*-
----------	---------	------------

DC ammeter



PRODUCT CODES - DC AMMETER

Rating	Scaling	Cat. no.
0-50 mV	To suit	•016-01A*-EC**
0-1 mA	To suit	•016-01A*-FA**
0-5 mA	To suit	•016-01A*-FX**
0-10 mA	To suit	•016-01A*-HA**
0-20 mA	To suit	•016-01A*-HF**

SUPPRESSED ZERO

PRODUCT CODES - MILLIAMMETERS - NO ZERO SET UNLESS SPECIFIED

Rating	Scaling	Cat. no.
4/20 mA	To suit	•016-01RA*-HG**

PRODUCT CODES - VOLTMETER - NO ZERO SET UNLESS SPECIFIED

Rating	Scaling	Cat. no.
1-5 V	To suit	016-01SA-LM**

** Customer must state required scaling at time of ordering.

DC voltmeter



PRODUCT CODES - SENSITIVITY 1000 Ω/V

Rating	Scaling	Cat. no.
0-15 V	0-15 V	•016-01V*-NDND
0-30 V	0-30 V	•016-01V*-NLNL
0-50 V	0-50 V	•016-01V*-NTNT
0-150 V	0-150 V	•016-01V*-PZPZ
0-300 V	0-300 V	•016-01V*-RXRX
0-600 V	0-600 V	•016-01V*-SJSJ

Frequency meter



PRODUCT CODES - 120 V, SELF CONTAINED

Rating	Scaling	Cat. no. standard case
50 Hz center frequency, -0.15 accuracy	45-55 Hz	•016-41S*-PNAG-AG
55 Hz center frequency, -0.25 accuracy	45-65 Hz	•016-41S*-PNAJ-AJ
60 Hz center frequency, -0.15 accuracy	55-65 Hz	•016-41S*-PNAN-AN
400 Hz center frequency, -1.25 accuracy	360-440 Hz	•016-41S*-PNBI-BI

Elapsed time meter



PRODUCT CODES - 99999.99 HOURS, NON-RESETTABLE

Rating	Scaling	Cat. no. standard case
110/130 V, 50 Hz	-	•016-155*-PNZH-C5
200/250 V, 50 Hz	-	•016-155*-RNZH-C5
480 V, 50 Hz	-	•016-155*-SEZH-C5
110/130 V, 60 Hz	-	•016-156*-PNZH-C6
200/250 V, 60 Hz	-	•016-156*-RNZH-C6
480 V, 60 Hz	-	•016-156*-SEZH-C6

Transducer indicators



PRODUCT CODES - DC MILLIAMP RATED

Rating	Scaling	Cat. no. standard case
Speed	To suit	016-012A
Frequency	To suit	016-013A
Phase angle	To suit	016-014A
Watts	To suit	016-015A
VArS	To suit	016-016A
VA	To suit	016-017A

- ** Customer must state required scaling at time of ordering.
 • UL approved





Chapter 4 Challenger analog panel meters

Challenger analog panel meters..... 48

Challenger analog panel meters

FEATURES

- Measurement and indication of AC amps, volts, frequency and DC signals
- Surface or window mounting
- Rear zero adjuster on moving coil meters
- High torque pivot and jewel movement
- True RMS measurement meters
- AC and DC inputs
- Up to 40 A DC direct connected
- Up to 50 A AC direct connected



APPLICATIONS

- Marine panels
- Switchgear
- Distribution systems
- Control panels
- Embedded generation
- Energy management
- Building management
- Utility power monitoring
- Process control
- Motor monitoring

APPROVALS

- ANSI C39.1 1981
- IEC 51
- UL3111-1
- EMC
- LVD
- UL CSA



BENEFITS

- AC moving iron and moving coil mechanisms
- Reduced inventory
- 4 ANSI standard case sizes
- Detachable lower fascia plate
- Easy to modify for distributors
- Through holes for back of panel mounting

The Challenger range of analog panel meters offers accurate measurement and indication of most electrical and electronic parameters in industry standard 1½", 2½", 3½" and 4½" case sizes. This innovative design features a detachable lower fascia plate, which allows the flexibility of either surface or window mounting. The fascia is simply unclipped to achieve the completely flush panel appearance of rear of panel window mounting.

AC moving coil rectified meters provide 1.5% accuracy of the full scale value and feature a rear zero adjuster screw for tamperproof installation. AC moving iron meters also provide 1.5% high accuracy and true RMS measurement.

OPERATION

The meters utilize a traditional pivot and jewel movement, incorporating specially hardened steel pivots and a spring loaded jewel. Ideally suited for all applications, including the most demanding conditions.

MOVING COIL METERS

These meters offer a centre cored, self-shielding moving coil movement using pivots, hairsprings and sprung jewels. Variations in movement are limited by design. All DC voltmeters are 1000 ohms per Volt, moving coil rectified products run at 900 ohms per Volt. Millivolt meters use a 5 milliamperes/50 mV movement.

MOVING IRON METERS

This clapper type repulsion design utilizes a pivot, hairspring and jewel movement. The bottom jewel is oil filled to provide damping while the top is sprung for resilience. All voltmeters are manufactured with internal voltage dropper resistors.

FREQUENCY METERS

Frequency meters utilize a 1mA/35 ohm DC moving coil movement driven by an EMC hard frequency conversion circuit.

DIALS, POINTERS AND SCALES

Dials are interchangeable between the Challenger meters for inputs within the published specifications of the meter. Options for non standard customized dials are available upon request.

CURRENT TRANSFORMERS AND SHUNTS

Our extensive range of current transformers provides accurate measurement of AC current and ratio matching to a consistent 5 or 1 amp secondary current, proportional to the primary current.

Our range of shunts ensures a DC millivolt signal exactly proportional to the system current for driving ammeters, providing accurate measurement of DC current up to 12000 A, with secondary inputs of, 50, 60, 75 or 100 mV DC to match the Challenger input.

Challenger analog panel meters

SPECIFICATIONS

Accuracy	
DC ammeters and voltmeters	1.5% 0-100% of full scale deflection
AC ammeters and voltmeters	Moving iron: 1.5% 10-100% of full scale deflection Moving coil: 1.5% 10-100% of full scale deflection
Frequency meters	0.5% of end scale value
Input ratings	
DC moving coil ammeters	100 μ A - 30 A DC. (Model 361: 10 A max)
DC moving coil voltmeters	50 mV - 600 V DC
DC moving coil center zero ammeters	+/-50 mA to +/-30 A DC. (Model 361: 10 A max)
DC moving coil center zero voltmeter	+/-50 mV to +/-600 V DC. Standard 1 k ohm/volt
DC moving coil suppressed zero ammeters	4/20 mA DC
DC moving coil suppressed zero voltmeters	1/5, 8/16, 16/32 or 12/24 V DC
AC moving coil ammeters	100 μ A - 750 mA AC
AC moving coil voltmeters	50 - 600 V AC. Standard 900 ohms/volt
AC moving iron ammeters	1 - 50 A AC (Model 361: non applicable)
AC moving iron voltmeters	50 - 600 V AC (Model 361: non applicable)
Frequency	100/130 V, 200/250 V, 360/440 V, 50 Hz, 60 Hz or 400 Hz (Model 361: non applicable)
Burden	Ammeter: 0.5 VA Voltmeter: 4.5 VA
Frequency	4 VA
Overload	1.2 continuous x 10 for 0.5 seconds
Enclosure	
Movement	High torque pivot and jewel moving coil and moving iron
Scale balance	Within 1% of scale length
Relative humidity	25% - 80% nominal range of use
Operating temperature	0°C to +40°C (-32°F to +104°F)
Storage temperature	-20°C +55°C (-4°F to +131°F)
Case and lower mask	Black matt case UL94V. Polycarbonate cover
Window	Shatterproof polycarbonate
Surface mounting	4 corner studs
Rear of panel mounting	2 through hole mounts (Model 361: facility pending)
Compliant with	
UL and CSA	File no: E203000
Performance	ANSI C39.1 1981 and IEC 51
Scaling	ANSI C39.1 1981
Safety	IEC61010-1 (LVD) and BS EN61326:1998 (EMC)
Vibration	ANSI C39.1 1981 cl. 5.13

CONNECTIONS

DC amps - self contained

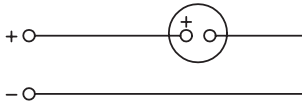

DC amps - for use with external shunt

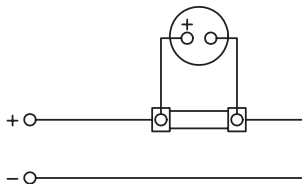

DC volts

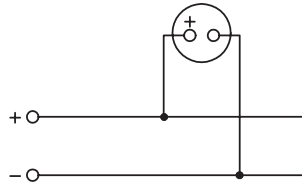

AC amps - self contained

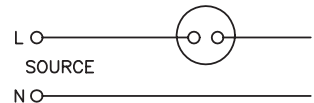

AC amps - For use with current transformer

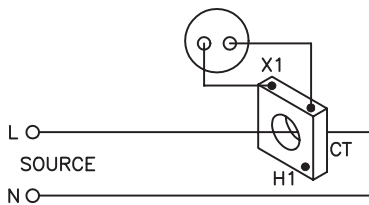

AC volts

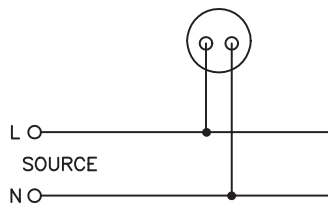

Frequency meter

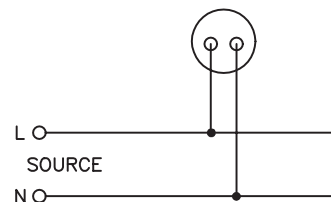

AC ammeter

MODEL 362 (2 1/2")



PRODUCT CODES - AC AMMETER TRUE RMS READING (ACCURACY ±2% ES)

Rating	Scaling	Cat. no.
5 A	0-5 A	(36*)-02AA-LSLS-C7
10 A	0-10 A	(36*)-02AA-MTMT-C7
15 A	0-15 A	(36*)-02AA-NDND-C7
20 A	0-20 A	(36*)-02AA-NGNG-C7
30 A	0-30 A	(36*)-02AA-NLNL-C7
1 A	Transformer rated	(36*)-02AA-LA** -C7
5 A	Transformer rated	(36*)-02AA-LS** -C7

AC voltmeter

MODEL 362 (2 1/2")



PRODUCT CODES - AC VOLTMETER TRUE RMS READING (ACCURACY ±2% ES)

Rating	Scaling	Cat. no.
150 V	0-150 V	(36*)-02VA-PZPZ-C7
300 V	0-300 V	(36*)-02VA-RXR X-C7
600 V	0-600 V	(36*)-02VA-SJSJ-C7
150 V	Transformer rated	(36*)-02VA-PZ** -C7

Milliammeters

MODEL 361 (1 1/2")



PRODUCT CODES - MILLIAMMETERS SUPPRESSED ZERO (ACCURACY ±2% ES)

Rating	Scaling	Cat. no.
4-20 mA	To suit requirements	(36*)-01RA-HG**
		**Specify scale value

DC voltmeter

MODEL 364 (4 1/2")



PRODUCT CODES - DC VOLTMETERS SENSITIVITY 1000Ω/VOLT (ACCURACY ±2% ES)

Rating	Scaling	Cat. no.
0-15 V	0-15 V	(36*)-01VA-NDND
0-30 V	0-30 V	(36*)-01VA-NLNL
0-50 V	0-50 V	(36*)-01VA-NTNT
0-150 V	0-150 V	(36*)-01VA-PZPZ
0-300 V	0-300 V	(36*)-01VA-RXR X
0-600 V	0-600 V	(36*)-01VA-SJSJ

DC ammeter



PRODUCT CODES - DC AMMETER (ACCURACY ±2% ES)

Rating	Scaling	Cat. no.
0-1 mA	To suit requirements	(36*)-01AA-FA**
0-5 mA	0-5 mA	(36*)-01AA-FXFX
0-10 mA	0-10 mA	(36*)-01AA-GZGZ
0-20 mA	0-20 mA	(36*)-01AA-HFHF
0-50 mA	0-50 mA	(36*)-01AA-HYHY
0-100 mA	0-100 mA	(36*)-01AA-JRJR
0-200 mA	0-200 mA	(36*)-01AA-KAKA
0-500 mA	0-500 mA	(36*)-01AA-KMKM
0-1 A	0-1 A	(36*)-01AA-LALA
0-2 A	0-2 A	(36*)-01AA-LELE
0-5 A	0-5 A	(36*)-01AA-LSLS
0-10 A	0-10 A	(36*)-01AA-MTMT
0-50 mV	To suit	(36*)-01AA-EC**

Frequency meter

MODEL 363 (3 1/2")



PRODUCT CODES - FREQUENCY METERS 120V, SELF CONTAINED

Rating	Scaling	Cat. no.
50 Hz	45-55 Hz	(36*)-41SA-PNAG-AG
55 Hz	45-65 Hz	(36*)-41SA-PNAJ-AJ
60 Hz	55-65 Hz	(36*)-41SA-PNAN-AN

Challenger analog panel meters

MODEL 361 (1½")



DIMENSIONS - SURFACE MOUNT

Model 361

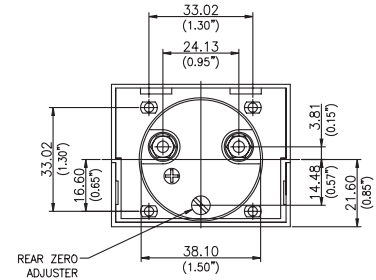
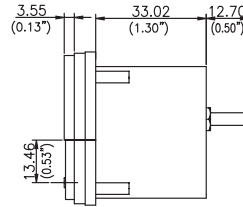
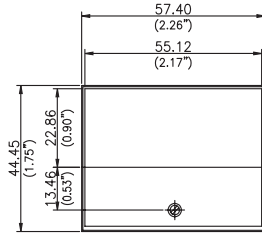

MODEL 362 (2½")



Model 362

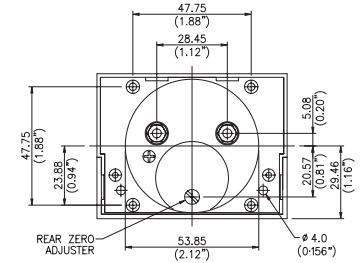
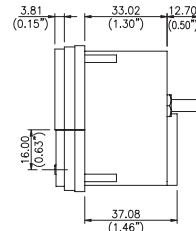
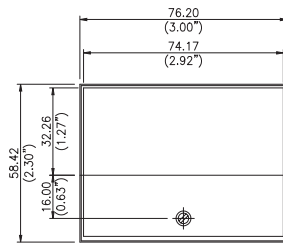

MODEL 363 (3½")



Model 363

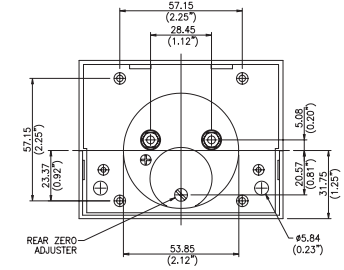
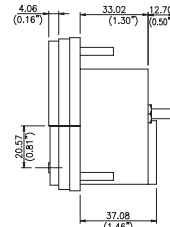
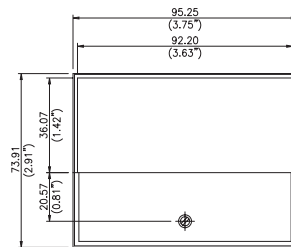

MODEL 364 (4½")



Model 364

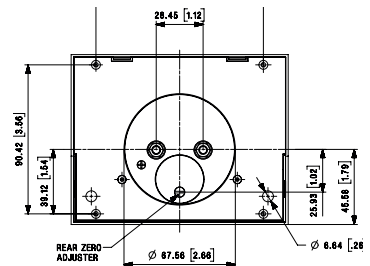
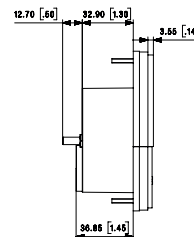
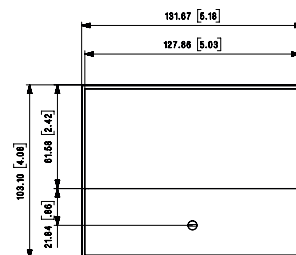

Challenger analog panel meters

Model 361
surface mount cut-out

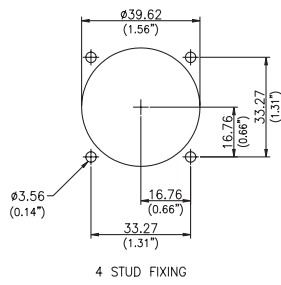

Window mount cut-out

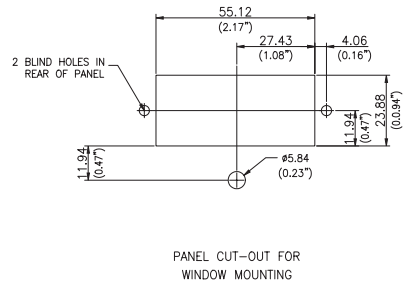

Model 362
surface mount cut-out

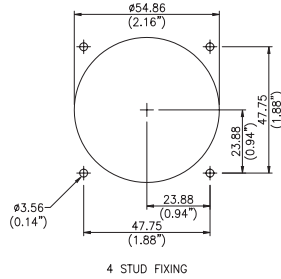

Window mount cut-out

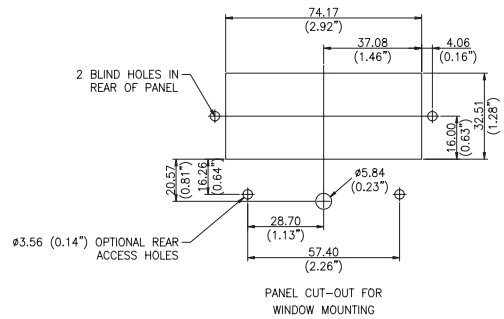

Model 363
surface mount cut-out

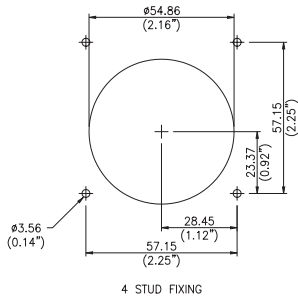

Window mount cut-out

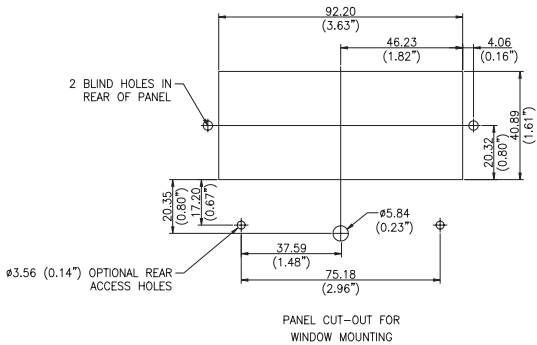

Model 364
surface mount cut-out

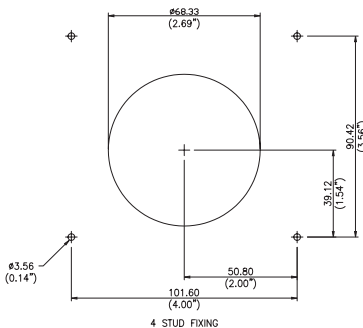

Window mount cut-out

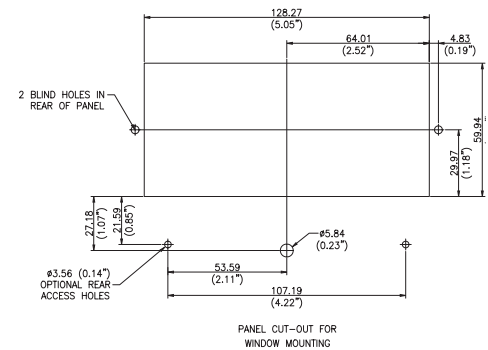





Chapter 5 ANSI switchboard meters

007 switchboard meters.....	56
ANSI switchboard meters.....	57
AC and DC ammeters, voltmeters and frequency meters.....	59
RMS reading AC ammeters.....	60
DC ammeters.....	62
DC voltmeters.....	63
Frequency meters.....	63
AC wattmeters and VArmeters.....	64
AC wattmeters.....	65
Wattmeter VArmeter scale selector guide.....	66
AC VArmeters.....	68
DC transducer indicators.....	68
007 synchroscope.....	69
Elapsed time meters.....	70
AC phase sequence, phase failure indicators.....	70
AC power factor meter.....	71
LED digital analog combination.....	72
Switchboard meter options	77

007 switchboard meters

FEATURES

- Low profile
- Class 1 accuracy
- Optional panel gasket
- Reliability
- Long scale 240°



APPLICATIONS

- Switchgear
- Distribution systems
- Energy management
- Process control
- Building management

APPROVALS

- UL approved file no. E203000



BENEFITS

- Enhanced safety
- Reinforced insulation
- ANSI C39.1

The Crompton Instruments compact ANSI switchboard meter offers Class 1 accuracy metering performance packed in a low profile, depth saving case. The 007 switchboard meters are a direct drop-in replacement for our legacy switchboard products.

The compact case also offers a lightweight, heavy duty polycarbonate case which is electrically safe. The 4½ inch meter complies with ANSI-C39.1 specifications.

PRODUCT CODES

Model	Function
007-05FA	AC rms reading ammeter, linear scale, left zero
007-05GA	AC rms reading voltmeter, linear scale, left zero
007-05VA	DC voltmeter, left zero
007-05AA	DC milliammeter/millivoltmeter, left zero
007-05CA	DC milliammeter/millivoltmeter, center zero
007-05RA	DC milliammeter, suppressed zero (4/20 mA etc)
007-055A	DC transducer indicator, scaled watts
007-056A	DC transducer indicator, scaled var
007-41LA	AC frequency meter
007-05BA	AC rectified ammeter
007-05PA	DC voltmeter, center zero
007-05NA	DC voltmeter, center zero
007-05ZA	DC voltmeter, expanded scale
007-05DA	DC ammeter, offset zero
007-05WA	AC rectified voltmeter
007-05YA	AC voltmeter, expanded scale

PRODUCT CODE AND ORDERING INFORMATION EXAMPLE

007-05GA-PZPZ-C7

RMS compensated Switchboard meter.

HOW TO ORDER

To order an equivalent for a 077, AB40 Or DB40 type meter, order exactly the same code, except replace 077 with 007.

E.g: 077-05FA-LSPK-C7 is 0-5A electrical scale, 0-100A dial AC ammeter, 50-60Hz. 007-05FA-LSPK-C7 provides identical specification in compact body style

DIMENSIONS

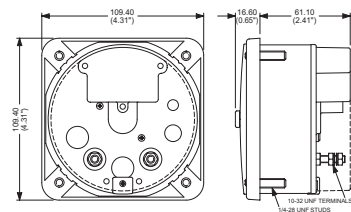

PANEL CUT OUT

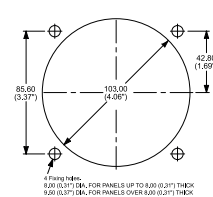

ANSI switchboard meters

FEATURES

- Rugged pivot and jewel movement
- Class 1 accuracy

APPROVALS

- c-UL UL listed
- E203000
- CE marked



BENEFITS

- Meets all the requirements of ANSI-C39.1 (1981)
- Parallax error-free platform dials
- Bump, shock and vibration proof
- Customized options and features



High quality range of switchboard instruments with Class 1 accuracy and which complies with American ANSI-C39.1 (1981) specifications. Available in 4 1/2" case size, the rugged design characteristics meet the needs of the most demanding environmental applications. This extensive range of analog and digital/analog meters utilizes high shock and provides 1% accuracy for all RMS AC and DC ranges. The range offers various customized options and features.

DESCRIPTION

Our Switchboard Meter series offers two case types; models 007 and 078.

Model 078 is high shock hermetically sealed and all models have heavy gauge pressed steel cases. Mounting is by four integral studs. Model 078 has a die-cast bezel and a projecting moulded toughened glass window, which incorporates a gas tight zero adjuster.

Model 007 is a one piece flame retardant polycarbonate moulding with a black matte finished bezel area, and a specially contoured window to minimize reflection from adjacent light sources.

APPLICATIONS

- Switchgear
- Distribution systems
- Generator sets
- Control panels
- Energy management
- Building management
- Utility power monitoring
- Process control
- Motor control

Scales are 240° moving iron and 250° moving coil with parallax error-free platform dials. Standard dials are white matte with black printed scales and bar knife-edge pointers.

SPECIFICATIONS

Performance	ANSI C39.1 (1981)
Accuracy	Class 1
Terminals	10 - 32 UNF terminals
Response time	Approximately 2.5 seconds to full scale (007 and 078)
Dielectric voltage	Withstand test 2.3 kV for 1 minute
Standard calibration	23°C
Operating temperature	0°C to +60°C. Model 078: -40°C to +70°C
Storage temperature	-10°C to +50°C
Extreme temperature range	-20°C to +65°C
Enclosure integrity	Model 007 to IP54 (NEMA 3S) splash proof, IP55 (NEMA 4) hoseproof is an optional extra Model 078 to IP67 (NEMA 6 and 6P)
Fixing on panel	4 integral 1/4 -28 UNF fixing studs
Certifications	c-UL-us, CE

DIMENSIONS (IN INCHES)

Model	Panel Cutout			Rear View		Side View		
	Dia	A	B	C	D	E	F	G
007 (Amps, Volts & Freq.)	4.06	3.37	1.69	4.31	0.65	2.41	-	4.05
007 Others	4.06	3.37	1.69	4.31	0.65	-	0.91	4.05
078	4.06	3.37	1.69	4.31	0.63	-	0.91	4.05

Dimension E on 007 others and 078 products varies with measured parameter.

See product code on following page.

Dimension F on 078 (Amps, Volts & Freq.) products is included with dimension E.

1-4 Fixing holes Ø 8mm. 2-1/4-28 UNF fixing studs. 3-10-32 UNF terminals.

007 POWER AND 078

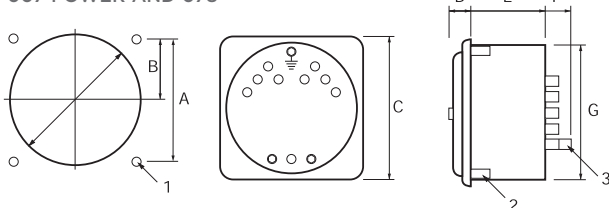

007 AMPS | VOLTS | FREQUENCY ONLY

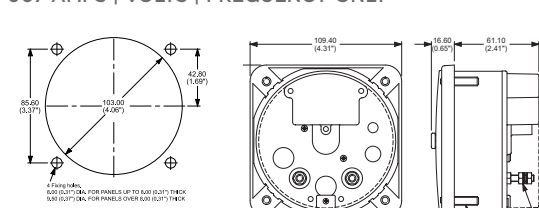

ANSI switchboard meters

Type of instrument	Ranges	Dimension E		Product code
		007	078	
AC rectified ammeter	1 - 30 A	56	86	007/078-05B
AC rectified voltmeter	30 - 800 V	56	86	007/078-05W
AC voltmeter expanded scale	110 - 130 V	86	86	007/078-05Y
AC RMS ammeter	1 - 30 A	56	86	007/078-05F
AC RMS voltmeter	150 - 750 V	56	86	007/078-05G
Elapsed time meter (99999.99)	50 or 60 Hz / 100 - 440 V* and DC	56	56	007/078-155/156/077-151
Frequency meter	50, 60	86	86	007/078-41L
AC wattmeter or VARmeter	0.2 - 10 A/100 - 440 V*	132	132	007/078-21 or 31
LED synchroscope only	63.5 - 480 V****	86	-	077-14A
LED synchroscope and synchro check relay	63.5 - 480 V****	86	-	077-14 L/G/D/U
Phase sequence indicator	100 - 150, 151 - 300, 301 - 500 V	56	-	077-12P
Transducer operated indicator	1, 5, 10, 20, or 4/20 mA	56	56	007/078-05
DC ammeter moving coil	200 μ A - 30 A 56	56	56	007/078-05A
DC voltmeter moving coil	50 mV - 600 V 56	56	56	007/078-05V
240° phase angle power factor	1 or 5 A, 100 - 400 V, 50, 60	132	132	007/078-42
DIGI/Analog AC ammeter	1 mA - 10 A	86	-	007-DIB
DIGI/Analog AC voltmeter	200 mV - 600 V	86	-	007-DIW
DIGI/Analog DC ammeter	1m A - 1 A	86	-	007-DIA
DIGI/Analog DC voltmeter	20 mV - 600 V	86	-	007-DIV
DIGI/Analog transducer indicator	DC mA	86	-	007-DIT
DIGI/Analog tachometer	AC or DC rated	86	-	007-DI2

* 100-440V = (100/125, 200/250, 380/440).

**100-440V = (100/125, 200/250, 380/440). Frequencies 45/55, 55/65, 45/65, 46/54, 50/70, 58/62, 56/64.

****Nominal voltage to be specified.

AC and DC ammeters, voltmeters and frequency meters

FEATURES

- 250° linear scale
- True RMS converting circuit
- RMS compensated rectifier
- Wide selection of AC and DC inputs



APPROVALS

- c-UL UL listed
- E203000



This range of self contained, pivot and jewel moving iron meters feature 250° linear scale. AC instruments are available with true RMS converting circuit or RMS compensated rectifier. While types of frequency meters can be damaged by transient supply voltage spike, Crompton Instruments 007-41 frequency meters can withstand, without damage, 10 successive transient spikes of 1250 volts. The range offers c-UL-us certification.

SPECIFICATIONS - GENERAL

Manufactured in accordance with American National Standards ANSI C39.1, (1981)

Accuracy	±1% full scale at 23°C (73°F)
Scales arc	250° full scale deflection
Scale length	007 and 078: 175.2 mm (6.9")
Scale plate	2 piece, platform type
Response time	007 and 078: Approximately 2.5 seconds to full scale
Operating temperature	0 to 40°C (32 to 104°F)
Storage temperature	-10 to +50°C (14 to 122°F)
Extreme temperature range	-20° to +65°C (-4° to 149°F)
Terminals	Standard 10-32 UNF stud. M5 screw clamp is optional
Dielectric withstand	2300 V AC for 1 minute between electrical circuit and case
Overshoot	33% maximum
Enclosure code	007: IP54, optional IP55 and 078: IP67A
Certification	c-UL-us

SPECIFICATIONS - AMMETERS AND VOLTMETERS

Overload rating	AC ammeters - 2 x continuous, 50 x for 1 second AC voltmeters and frequency meters - 1.2 x continuous DC ammeters - 2 x continuous 10 x for 1 second DC voltmeters - 1.2 x continuous
Frequency range	AC calibration 50/60Hz ±20%

SPECIFICATIONS - FREQUENCY METERS

Response time	3 seconds maximum
External temperature influence	0.6 times accuracy maximum with ±10°C from reference temperature
External field influence	2.0 times accuracy maximum with 0.5m T field
Acceptable input harmonic influence	up to 30% distortion

Maximum Frequency - Hz	Center Scale - Hz	Error in Hz
45-55	50	0.15
46-54	50	0.15
45-65	55	0.25
50-70	60	0.25
55-65	60	0.15
56-64	60	0.15

FIG. AA 007-05/007-41

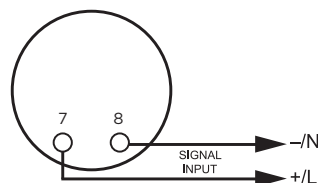

RMS reading AC ammeters

AC AMMETER



PRODUCT CODES - SELF CONTAINED 40/70HZ - ACCURACY $\pm 1\%$, 60HZ***

Rating	Scaling*	4 1/2" square flange	
		Std. case catalogue number	Std. case hi-shock catalogue number
1A	0-1A	•007-05FA-LALA-C7	078-05FJ-LALA-C6
1.5A	0-1.5A	•007-05FA-LCLC-C7	078-05FJ-LCLC-C6
2A	0-2A	•007-05FA-LELE-C7	078-05FJ-LELE-C6
3A	0-3A	•007-05FA-LJLJ-C7	078-05FJ-LJLJ-C6
5A	0-5A	•007-05FA-LSLS-C7	078-05FJ-LSLS-C6
7.5A	0-7.5A	•007-05FA-MFMF-C7	078-05FJ-MFMF-C6
10A	0-10A	•007-05FA-MTMT-C7	078-05FJ-MTMT-C6
15A	0-15A	•007-05FA-NDND-C7	078-05FJ-NDND-C6
20A	0-20A	•007-05FA-NGNG-C7	078-05FJ-NGNG-C6
30A	0-30A	•007-05FA-NLNL-C7	078-05FJ-NLNL-C6

For AC rectified non-RMS compensated meter, please replace the -05F in the product code with -05B.

PRODUCT CODES - TRANSFORMER RATED 40/70HZ - BURDEN 0.3VA***

Rating	Scaling*	4 1/2" square flange	
		Std. case catalogue number	Std. case hi-shock catalogue number
5A	0-10A	•007-05FA-LSMT-C7	078-05FJ-LSMT-C6
5A	0-15A	•007-05FA-LSND-C7	078-05FJ-LSND-C6
5A	0-20A	•007-05FA-LSNG-C7	078-05FJ-LSNG-C6
5A	0-25A	•007-05FA-LSNJ-C7	078-05FJ-LSNJ-C6
5A	0-30A	•007-05FA-LSNL-C7	078-05FJ-LSNL-C6
5A	0-40A	•007-05FA-LSNP-C7	078-05FJ-LSNP-C6
5A	0-50A	•007-05FA-LSNT-C7	078-05FJ-LSNT-C6
5A	0-75A	•007-05FA-LSPB-C7	078-05FJ-LSPB-C6
5A	0-100A	•007-05FA-LSPK-C7	078-05FJ-LSPK-C6
5A	0-150A	•007-05FA-LSPZ-C7	078-05FJ-LSPZ-C6
5A	0-200A	•007-05FA-LSRL-C7	078-05FJ-LSRL-C6
5A	0-250A	•007-05FA-LSRS-C7	078-05FJ-LSRS-C6
5A	0-300A	•007-05FA-LSRX-C7	078-05FJ-LSRX-C6
5A	0-400A	•007-05FA-LSSC-C7	078-05FJ-LSSC-C6
5A	0-500A	•007-05FA-LSSF-C7	078-05FJ-LSSF-C6
5A	0-600A	•007-05FA-LSSJ-C7	078-05FJ-LSSJ-C6
5A	0-800A	•007-05FA-LSSN-C7	078-05FJ-LSSN-C6
5A	0-1000A	•007-05FA-LSSS-C7	078-05FJ-LSSS-C6
5A	0-1200A	•007-05FA-LSSU-C7	078-05FJ-LSSU-C6
5A	0-1500A	•007-05FA-LSTC-C7	078-05FJ-LSTC-C6
5A	0-1600A	•007-05FA-LSTE-C7	078-05FJ-LSTE-C6
5A	0-2000A	•007-05FA-LSTM-C7	078-05FJ-LSTM-C6
5A	0-2500A	•007-05FA-LSTU-C7	078-05FJ-LSTU-C6
5A	0-3000A	•007-05FA-LSUA-C7	078-05FJ-LSUA-C6
5A	0-4000A	•007-05FA-LSUE-C7	078-05FJ-LSUE-C6
5A	0-5000A	•007-05FA-LSUJ-C7	078-05FJ-LSUJ-C6
5A	0-6000A	•007-05FA-LSUP-C7	078-05FJ-LSUP-C6
5A	0-7000A	•007-05FA-LSUS-C7	078-05FJ-LSUS-C6
5A	0-8000A	•007-05FA-LSUW-C7	078-05FJ-LSUW-C6

For AC rectified non-RMS compensated meter, please replace the -05F in the product code with -05B.

* Other scales are available.

*** For case types 007/078 use 10-32 UNF terminals.

• c-UL-us certified.

RMS reading AC voltmeters

AC VOLTMETER



PRODUCT CODES - SELF CONTAINED 50/60HZ ± 20% - ACCURACY ±1%***

Rating	Scaling*	4 1/2" square flange	
		Std. case catalogue number	Std. case hi-shock catalogue number
150V	0-150V	•007-05GA-PZPZ-C7	078-05GJ-PZPZ-C6
250V	0-250V	•007-05GA-RSRS-C7	078-05GJ-RSRS-C6
300V	0-300V	•007-05GA-RXRX-C7	078-05GJ-RXRX-C6
500V	0-500V	•007-05GA-SFSF-C7	078-05GJ-SFSF-C6
600V	0-600V	•007-05GA-SJSJ-C7	078-05GJ-SJSJ-C6
750V	0-750V	007-05GA-SMSM-C7	078-05GJ-SMSM-C6

For AC rectified non-RMS compensated meter, please replace the -05G in the product code with -05W.

PRODUCT CODES - TRANSFORMER RATED 50/60HZ - ACCURACY ±1% 0.8VA @ 150V***

Rating	Scaling*	4 1/2" square flange	
		Std. case catalogue number	Std. case hi-shock catalogue number
150V	0-300V	•007-05GA-PZRX-C7	078-05GJ-PZRX-C6
150V	0-600V	•007-05GA-PZSJ-C7	078-05GJ-PZSJ-C6
150V	0-750V	•007-05GA-PZSM-C7	078-05GJ-PZSM-C6
150V	0-3000V	•007-05GA-PZUA-C7	078-05GJ-PZUA-C6
150V	0-5250V	•007-05GA-PZUL-C7	078-05GJ-PZUL-C6
150V	0-6000V	•007-05GA-PZUP-C7	078-05GJ-PZUP-C6
150V	0-9000V	•007-05GA-PZUY-C7	078-05GJ-PZUY-C6
150V	0-15kV	•007-05GA-PZWC-C7	078-05GJ-PZWC-C6
150V	0-18kV	•007-05GA-PZWD-C7	078-05GJ-PZWD-C6
150V	0-45kV	•007-05GA-PZWJ-C7	078-05GJ-PZWJ-C6
250V	0-600V	•007-05GA-RSSJ-C7	078-05GJ-RSSJ-C6

For AC rectified non-RMS compensated meter, please replace the -05G in the product code with -05W.

AC VOLTMETER - EXPANDED SCALE



PRODUCT CODES - EXPANDED SCALE - MOVING COIL ZENER DIODE *** ACCURACY ±0.3% OF MID-SCALE VALUE SELF CONTAINED, 20-1000HZ

Rating	Scaling*	4 1/2" square flange	
		Std. case catalogue number	Std. case hi-shock catalogue number
110-130V	110-130V	007-05YA-PNPN-C6	078-05YJ-PNPN-C6
110-130V	To suit PT	007-05YA-PN**-C6	078-05YJ-PN**-C6

* Other scales are available.

** Scaling information provided at time of order.

*** For case types 007/078 use 10-32 UNF terminals.

- c-UL-us listed.

DC ammeters



PRODUCT CODES - SELF CONTAINED - ACCURACY $\pm 1\%$ ***

Rating	Scaling*	4 1/2" square flange	
		Std. case catalogue number	Std. case hi-shock catalogue number
0-200 μ A	0-200 μ A	•007-05AA-EAEA	078-05AJ-EAEA
0-300 μ A	0-300 μ A	•007-05AA-EEEE	078-05AJ-EEEE
0-500 μ A	0-500 μ A	•007-05AA-EMEM	078-05AJ-EMEM
0-800 μ A	0-800 μ A	•007-05AA-EWEW	078-05AJ-EWEW
0-1mA	0-1mA	•007-05AA-FAFA	078-05AJ-FAFA
0-2mA	0-2mA	•007-05AA-FGFG	078-05AJ-FGFG
0-5mA	0-5mA	•007-05AA-FXFX	078-05AJ-FXFX
0-10mA	0-10mA	•007-05AA-HAHA	078-05AJ-HAHA
0-20mA	0-20mA	•007-05AA-HFHF	078-05AJ-HFHF
0-30mA	0-30mA	•007-05AA-HMHM	078-05AJ-HMHM
0-50mA	0-50mA	•007-05AA-HXHY	078-05AJ-HXHY
0-100mA	0-100mA	•007-05AA-JRJR	078-05AJ-JRJR
0-200mA	0-200mA	•007-05AA-KAKA	078-05AJ-KAKA
0-300mA	0-300mA	•007-05AA-KGKG	078-05AJ-KGKG
0-500mA	0-500mA	•007-05AA-KMKM	078-05AJ-KMKM
0-800mA	0-800mA	•007-05AA-KWKW	078-05AJ-KWKW
0-1A	0-1A	•007-05AA-LALA	078-05AJ-LALA
0-5A	0-5A	•007-05AA-LSLS	078-05AJ-LSLS
0-10A	0-10A	•007-05AA-MTMT	078-05AJ-MTMT
0-15A	0-15A	•007-05AA-NDND	078-05AJ-NDND
0-20A	0-20A	•007-05AA-NGNG	078-05AJ-NGNG
0-30A	0-30A	•007-05AA-NLNL	078-05AJ-NLNL

PRODUCT CODES - MILLIMETERS - SUPPRESSED ZERO, NO ZERO ADJUST UNLESS SPECIFIED

Rating	Scaling*	4 1/2" square flange	
		Std. case catalogue number	Std. case hi-shock catalogue number
1/5mA	To Suit	•007-05RA-GM**	078-05RJ-GM**
4/20mA	To Suit	•007-05RA-HG**	078-05RJ-HG**
10/50mA	To Suit	•007-05RA-HZ**	078-05RJ-HZ**

PRODUCT CODES - SHUNT RATED - ACCURACY $\pm 1\%$ ***

Rating	Scaling*	4 1/2" square flange	
		Std. case catalogue number	Std. case hi-shock catalogue number
50mV	To suit shunt rating	•007-05AA-EY**	078-05AJ-EY**
50-0-50mV		•007-05CA-GB**	078-05CJ-GB**
100mV		•007-05AA-GB**	078-05AJ-GB**
100-0-100mV		•007-05CA-GM**	078-05CJ-GM**

PRODUCT CODES - ZERO LEFT FOR USE WITH 50 MV SHUNTS AND 0.05 OHM SHUNT LEADS***AND ****

Rating	Scaling*	4 1/2" square flange	
		Std. case catalogue number	Std. case hi-shock catalogue number
50mV	0-15A	•007-05AA-EYND	078-05AJ-EYND
50mV	0-20A	•007-05AA-EYNG	078-05AJ-EYNG
50mV	0-30A	•007-05AA-EYNL	078-05AJ-EYNL
50mV	0-40A	•007-05AA-EYNP	078-05AJ-EYNP
50mV	0-75A	•007-05AA-EYPB	078-05AJ-EYPB
50mV	0-100A	•007-05AA-EYPK	078-05AJ-EYPK
50mV	0-150A	•007-05AA-EYPZ	078-05AJ-EYPZ
50mV	0-200A	•007-05AA-EYRL	078-05AJ-EYRL
50mV	0-300A	•007-05AA-EYRX	078-05AJ-EYRX
50mV	0-400A	•007-05AA-EYSC	078-05AJ-EYSC
50mV	0-500A	•007-05AA-EYSF	078-05AJ-EYSF
50mV	0-750A	•007-05AA-EYSM	078-05AJ-EYSM
50mV	0-1000A	•007-05AA-EYSS	078-05AJ-EYSS
50mV	0-1200A	•007-05AA-EYSU	078-05AJ-EYSU
50mV	0-1500A	•007-05AA-EYTC	078-05AJ-EYTC
50mV	0-2000A	•007-05AA-EYTM	078-05AJ-EYTM
50mV	0-3000A	•007-05AA-EYUA	078-05AJ-EYUA

- c-UL-us certified. Specify shunt lead resistance value if in excess of 0.05 ohms for calibration purposes. DC shunt rated ammeters have thermistor circuit ambient temperature compensation. Separate shunt and shunt leads are not included.
- * Other scales are available.
- ** Specify scale required.
- *** Other mV ratings and scale options available upon request.
- **** For case types 007/078 use 10-32 UNF terminals.

DC voltmeters



PRODUCT CODES - SENSITIVITY 1000 OHMS / VOLT - ACCURACY $\pm 1\%$ ***

Rating	Scaling*	4 1/2" square flange	
		Std. case catalogue number	Std. case hi-shock catalogue number
500MV-800V	To suit	•007-05VA-**	078-05VJ-**
0-15V	0-15V	•007-05VA-NDND	078-05VJ-NDND
0-30V	0-30V	•007-05VA-NLNL	078-05VJ-NLNL
0-50V	0-50V	•007-05VA-NTNT	078-05VJ-NTNT
0-75V	0-75V	•007-05VA-PBPB	078-05VJ-PBPB
0-150V	0-150V	•007-05VA-PZPZ	078-05VJ-PZPZ
0-300V	0-300V	•007-05VA-RXRX	078-05VJ-RXRX
0-400V	0-400V	•007-05VA-SCSC	078-05VJ-SCSC
0-500V	0-500V	•007-05VA-SFSF	078-05VJ-SFSF
0-600V	0-600V	•007-05VA-SJSJ	078-05VJ-SJSJ
0-750V	0-750V	007-05VA-SMSM	078-05VJ-SMSM
0-800V	0-800V	007-05VA-SNSN	078-05VJ-SNSN

PRODUCT CODES - ZERO CENTER - SENSITIVITY 2000 OHMS / VOLT ACCURACY $\pm 1\%$ ***

Rating	Scaling*	4 1/2" square flange	
		Std. case catalogue number	Std. case hi-shock catalogue number
150-0-150V	150-0-150V	•007-05NA-RXRX	078-05NJ-RXRX
300-0-300V	300-0-300V	•007-05NA-SJSJ	078-05NJ-SJSJ
500-0-500V	500-0-500V	•007-05NA-SSSS	078-05NJ-SSSS
600-0-600V	600-0-600V	•007-05NA-SUSU	078-05NJ-SUSU

Frequency meters



PRODUCT CODES - 120V SELF CONTAINED***

Rating	Scaling*	4 1/2" square flange	
		Std. case catalogue number	Std. case hi-shock catalogue number
50Hz +/-0.15	45-55Hz	•007-41LA-PNAG-AG	078-41LJ-PNAG-AG
50Hz +/-0.15	46-54Hz	•007-41LA-PNAH-AH	078-41LJ-PNAH-AH
50Hz +/-0.25	45-65Hz	•007-41LA-PNAJ-AJ	078-41LJ-PNAJ-AJ
60Hz +/-0.25	50-70Hz	•007-41LA-PNAL-AL	078-41LJ-PNAL-AL
60Hz +/-0.15	55-65Hz	•007-41LA-PNAN-AN	078-41LJ-PNAN-AN
60Hz +/-0.15	56-64Hz	•007-41LA-PNAO-AO	078-41LJ-PNAO-AO
60Hz +/-0.08	58-62Hz	•007-41LA-PNAT-AT	078-41LJ-PNAT-AT

For alternative voltage rating 200-250V, use code RN instead of PN.

For alternative voltage rating 380-480V, case types 007/078 use code SE instead of PN.

10-32 UNF terminals.

* Other scales are available.

** Specify scale required.

*** For case types 007/078 use 10-32 UNF terminals.

• c-UL-us certified.

AC wattmeters and VArmeters



The Crompton Instruments Switchboard series of AC Wattmeters and VArmeters incorporate a DC moving coil, pivot and jewel indicator with a micro-circuit watt transducer PCB to read power on single or three phase systems with optional transformer isolation. The most frequently selected wattmeter scale marking for common current and voltage transformers are listed on the following pages. In addition, these instruments may be supplied with zero-left or centre-zero scale.

SCALING

Wattmeter and VArmeter current circuits should have equal carrying capacity because they are frequently connected in series. This means that the sum of the left and right end-scale values of the VArmeters should be equal to or greater than the full scale value of the Wattmeter (or have higher end-scale values if the instruments are centre or offset-zero). Instruments measuring 10,000 kilowatts and over are marked in megawatts. Centre-zero or offset-zero Watt and VArmeters are marked "IN" for left deflection and "OUT" for right deflection. On ordering, Wattmeter and VArmeter scales will be calculate, the nearest preferred scale will be offered from the charts on the following pages. Custom scales are available but at an extra cost.

CALIBRATION

For full load value of Watts or VAR, assuming unity power factor:

1-phase 2-wire Watts = amps x volts

3-phase 3-wire Watts = amps x line-to-line volts x $\sqrt{3}$

3-phase 4-wire Watts = amps x line-to-neutral volts x 3

Minimum scale values are obtained by multiplying resultant Watts, using the above formula x 0.7 and selecting next higher standard scale.

For maximum scale value, multiply x 1.3 and select the next lowest standard.

If scale calculates to an exact listed value, use this value rather than the next higher or lower value.

Note: When ordering Wattmeters and VArmeters, please specify CT ratio, VT ratio and required scale.

SPECIFICATIONS

Burden per element	Current circuit: 2VA Voltage Circuit: 1VA
Accuracy	Class 1.0
Ambient range	0° to ± 60° (32° to 104°F) std. calibration 20°C (68°F)
Ambient influence	0.05% per 1°C maximum
Overloads-current	10 x rating for 5 seconds, 1.2 x continuously
Voltage influence	2 x rating for 5 seconds, 1.2 x continuously voltage Accuracy maintained, 80 - 110% rated voltage
Power factor influence	Accuracy maintained, 0.1 lag to 0.1 lead
Enclosure code	007 IP54 optional IP55 078 IP67
Response time	007 and 078 approximately 2.5 seconds
Dielectric withstand	Live parts to case including panel 2600V RMS for 1 minute

AC wattmeters



PRODUCT CODES - 1-ELEMENT, TRANSFORMER RATED, 50/60HZ
INTEGRAL TRANSDUCER - ACCURACY 1.0%, 50/60HZ

Measured System		Scaling	4 1/2" square flange			
Phases	Wires		Std. case catalogue number	Std. case hi-shock catalogue number		
1	2	5	120V	To suit	•007-215A-QQ**-C7	078-215J-QQ**-C6
1	2	5	240V	To suit	007-215A-QS**-C7	078-215J-QS**-C6

For connection diagram refer to Figure A1 & A2.

PRODUCT CODES - 2 -ELEMENT, TRANSFORMER RATED, 50/60HZ
TAUT BAND INTEGRAL TRANSDUCER - ACCURACY 1.0%, 50/60HZ

Measured System		Scaling	4 1/2" square flange			
Phases	Wires		Std. case catalogue number	Std. case hi-shock catalogue number		
3	3	5	120V	To suit	•007-218A-QQ**-C7	078-218J-QQ**-C6
3	3	5	208V	To suit	•007-218A-QR**-C7	078-218J-QR**-C6
3	3	5	240V	To suit	•007-218A-QS**-C7	078-218J-QS**-C6
3	3	5	380V	To suit	•007-218A-QX**-C7	078-218J-QX**-C6
3	3	5	480V	To suit	•007-218A-QT**-C7	078-218J-QT**-C6

For connection diagram refer to Figure B1 & B2.

PRODUCT CODES - 2 1/2 - ELEMENT, TRANSFORMER RATED, 50/60HZ
TAUT BAND INTEGRAL TRANSDUCER - ACCURACY 1.0%, 50/60HZ

Measured System		Scaling	4 1/2" square flange			
Phases	Wires		Std. case catalogue number	Std. case hi-shock catalogue number		
3	4	5	69V	To suit	•007-219A-QL-C7**	078-219J-QL**-C6
3	4	5	120V	To suit	•007-219A-QQ-C7**	078-219J-QQ**-C6
3	4	5	277V	To suit	•007-219A-QY-C7**	078-219J-QY**-C6
3	4	5	346V	To suit	•007-219A-QZ-C7**	078-219J-QZ**-C6

For connection diagram refer to Figure C1 & C2.

- * Other scales are available.
- ** Specify CT (Current Transformer) and VT (Voltage Transformer) ratios if used and preferred scale at time of ordering.
- c-UL-us certified.

Fig. A1 Models 007-215 Wattmeter single phase

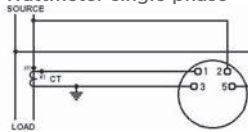

Fig. A2 Models 078-215 Wattmeter single phase

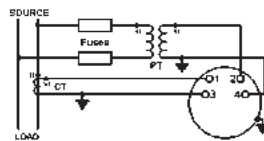

Fig. B1 Models 007-218 Wattmeter 3-phase, 3-wire unbalanced load

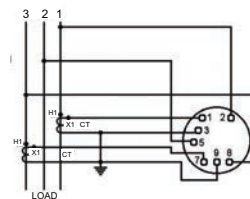

Fig. C1 Models 007-219 Wattmeter 3-phase 4-wire unbalanced load

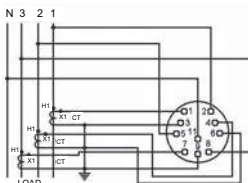

Fig. B2 Models 078-218 Wattmeter 3-phase 3-wire unbalanced load

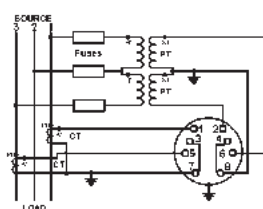
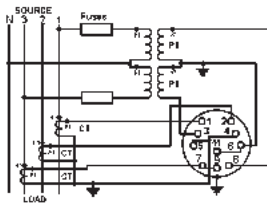

Fig. C2 Models 078-219 Wattmeter 3-phase 4-wire unbalanced load



Wattmeter | VArmeter scale selector guide

		120	208	240	480	600	2400	3600	4200	4800	6000	7200	8400
Primary potential transformer voltage system		(1:1)	(1.73:1)	(2:1)	(4:1)	(5:1)	(20:1)	(30:1)	(35:1)	(40:1)	(50:1)	(60:1)	(70:1)
3-phase 3-wire (L-L) system voltage		120	208	240	480	600	2400	3600	4200	4800	6000	7200	8400
3-phase 4-wire (L-N) current transformer		69	120	139	277	347	1390	2100	2400	2770	3500	4160	4800
RATIO 25/5 (5:1)	Normal	5KW	10KW	10KW	20KW	25KW	100KW	150KW	175KW	200KW	250KW	300KW	350KW
	Max. Min.	6 3	10 5	12 6	25 12.5	30 15	120 60	200 100	250 100	300 125	400 150	500 200	600 225
RATIO 50/5 (10:1)	Normal	10KW	20KW	20KW	40KW	50KW	200KW	300KW	350KW	400KW	500KW	600KW	700KW
	Max. Min.	12 6	20 10	25 12.5	50 25	60 30	250 125	400 200	450 250	500 250	600 300	800 400	900 450
RATIO 75/5 (15:1)	Normal	15KW	25KW	30KW	60KW	75KW	300KW	500KW	500KW	600KW	750KW	900KW	1000KW
	Max. Min.	20 10	30 15	40 20	80 40	100 50	400 200	700 350	600 300	800 400	1000 500	1200 600	1200 600
RATIO 100/5 (20:1)	Normal	20KW	30KW	40KW	75KW	100KW	400KW	600KW	700KW	800KW	1000KW	1200KW	1200KW
	Max. Min.	25 12.5	40 20	50 25	100 50	120 60	500 250	800 400	900 450	1000 500	1200 600	1500 750	100 750
RATIO 150/5 (30:1)	Normal	30KW	50KW	50KW	100KW	150KW	600KW	800KW	1000KW	1200KW	1500KW	1800KW	2000KW
	Max. Min.	40 20	70 35	75 35	150 75	200 100	800 400	1200 600	1200 600	1500 750	2000 1000	2400 1000	2500 1250
RATIO 200/5 (40:1)	Normal	40KW	75KW	75KW	150KW	200KW	800KW	1200KW	1200KW	1500KW	2000KW	2500KW	3000KW
	Max. Min.	50 25	80 40	100 50	200 100	250 125	1000 500	1500 750	1500 750	2000 1000	2500 1250	3000 1500	3500 1500
RATIO 300/5 (60:1)	Normal	70KW	100KW	100KW	200KW	300KW	1200KW	1500KW	2000KW	2500KW	3000KW	3500KW	4500KW
	Max. Min.	75 35	120 60	150 75	300 150	400 200	1500 750	2000 1000	2500 1250	3000 1500	4000 2000	4000 2000	5000 2500
RATIO 400/5 (80:1)	Normal	75KW	125KW	150KW	300KW	400KW	1500KW	2500KW	3000KW	3000KW	4000KW	5000KW	6000KW
	Max. Min.	100 50	150 75	200 100	400 200	500 250	2000 1000	3000 1500	3600 1800	4000 2000	5000 2500	6000 3000	7000 3500
RATIO 600/5 (120:1)	Normal	125KW	200KW	200KW	450KW	600KW	2000KW	3000KW	4000KW	5000KW	6000KW	7500KW	8000KW
	Max. Min.	150 75	250 125	300 150	600 300	800 400	3000 1500	4000 2000	5000 2500	6000 3000	8000 4000	10000 5000	10000 5000KW
RATIO 800/5 (160:1)	Normal	150KW	250KW	300KW	600KW	800KW	3000KW	5000KW	6000KW	6000KW	8000KW	10MW	12MW
	Max. Min.	200 100	350 175	400 200	800 400	1000 500	4000 2000	6000 3000	7500 3000	8000 4000	10000 5000KW	12MW 6000KW	15MW 7500KW
RATIO 1000/5 (200:1)	Normal	200KW	350KW	400KW	800KW	1000KW	4000KW	6000KW	6000KW	8000KW	10MW	12MW	15MW
	Max. Min.	250 125	450 225	500 250	1000 500	1200 600	5000 2500	8000 4000	8000 4000	10MW 5000KW	12MW 6000KW	15MW 7500KW	18MW 9000KW
RATIO 1200/5 (240:1)	Normal	250KW	400KW	500KW	1000KW	1200KW	5000KW	7000KW	8000KW	10MW	12MW	15MW	10MW
	Max. Min.	300 150	500 250	600 300	1200 600	1500 750	6000 3000	8000 4000	8000KW 5000KW	10MW 6000KW	12MW 7500KW	15MW 7500KW	10MW 10MW
RATIO 1500/5 (300:1)	Normal	300KW	500KW	600KW	1200KW	1500KW	6000KW	10MW	10MW	12MW	15MW	20MW	20MW
	Max. Min.	400 200	700 350	750 375	1500 1000	2000 1000	8000 4000	12MW 6000KW	12MW 6000KW	15MW 7500KW	20MW 10MW	25MW 12.5MW	25MW 12.5MW
RATIO 2000/5 (400:1)	Normal	400KW	750KW	800KW	1600KW	2000KW	8000KW	12MW	12MW	15MW	20MW	25MW	30MW
	Max. Min.	500 250	800 400	1000 500	2000 1000	2500 1250	10000 5000	15MW 7500KW	15MW 7500KW	20MW 10MW	25MW 12.5MW	30MW 15MW	35MW 17.5MW
RATIO 3000/5 (600:1)	Normal	750KW	1000KW	1200KW	2000KW	3000KW	12MW	18MW	20MW	25MW	30MW	35MW	40MW
	Max. Min.	800 400	1200 600	1500 750	3000 1500	4000 2000	15MW 7500KW	20MW 10MW	25MW 12.5MW	30MW 15MW	40MW 20MW	50MW 25MW	60MW 30MW
RATIO 4000/5 (800:1)	Normal	800KW	1200KW	1500KW	3000KW	4000KW	15MW	20MW	25MW	30MW	40MW	50MW	50MW
	Max. Min.	1000 500	1500 750	2000 1000	4000 2000	5000 2500	20MW 10MW	30MW 15MW	30MW 15MW	40MW 20MW	50MW 25MW	60MW 30MW	75MW 37.5MW
RATIO 5000/5 (1000:1)	Normal	1000KW	1500KW	2000KW	4000KW	5000KW	20MW	30MW	20MW	40MW	50MW	60MW	75MW
	Max. Min.	1250 500	2000 1000	2500 1250	5000 2500	6000 3000	25MW 12.5MW	40MW 20MW	25MW 12.5MW	50MW 25MW	60MW 30MW	80MW 40MW	100MW 50MW
RATIO 6000/5 (1200:1)	Normal	1200KW	2000KW	2500KW	5000KW	6000KW	25MW	35MW	40MW	50MW	60MW	60MW	80MW
	Max. Min.	1500 750	2500 1250	3000 1500	6000 3000	8000 4000	30MW 15MW	40MW 20MW	50MW 25MW	60MW 30MW	80MW 40MW	100MW 50MW	100MW 50MW

Wattmeter | VArmeter scale selector guide

		12kV	14.4kV	24kV	34.5kV	38kV	46kV	92kV	115kV	138kV	345kV	765kV
		(100:1)	(120:1)	(200:1)	(300:1)	(330:1)	(400:1)	(800:1)	(1000:1)	(1200:1)	(3000:1)	(6000:1)
Primary potential transformer voltage system												
3-phase 3-wire (L-L) system voltage		12KV	14.4kV	24kV	34.5kV	38kV	46kV	92kV	115kV	138kV	345kV	765kV
3-phase 4-wire (L-N) current transformer		6900	8300	13.8KV	20kV	22kV	26.5kV	53kV	66kV	80kV	200kV	440kV
RATIO 25/5 (5:1)	Normal Max. Min.	500KW 650 325	600KW 800 400	1000KW 1200 600	1500KW 1500 750	1500KW 2000 1000	1500KW 2500 1250	3000KW 200 100	5000KW 200 100	6000KW 250 125	15MW 300 150	30MW 400 200
RATIO 50/5 (10:1)	Normal Max. Min.	1000KW 1200 600	1200KW 1500 750	2000KW 2500 1250	3000KW 3500 1750	3000KW 4000 2000	3500KW 5000 2500	8000KW 10MW 5000KW	10MW 12 6000KW	12MW 15 7500KW	30MW 35 15	60MW 80 40
RATIO 75/5 (15:1)	Normal Max. Min.	1500KW 2000 1000	1800KW 2000 1000	3000KW 4000 2000	4000KW 5000 2500	5000KW 6000 3000	5000KW 7500 3000	10MW 15 7500KW	15MW 15 7500KW	15MW 20 10	45MW 50 25	100MW 125 50
RATIO 100/5 (20:1)	Normal Max. Min.	2000KW 2500 1250	2500KW 3000 1500	4000KW 5000 2500	6000KW 7500 3000	6000KW 8000 4000	7500KW 10MW 5000KW	15MW 20 10	20MW 25 12.5	25MW 30 15	60MW 70 35	125MW 150 75
RATIO 150/5 (30:1)	Normal Max. Min.	3000KW 4000 2000	3500KW 4000 2000	6000KW 8000 4000	10MW 12 6000KW	10MW 12 6000KW	10MW 15 7500KW	20MW 30 15	30MW 35 15	35MW 40 20	90MW 100 50	200MW 250 100
RATIO 200/5 (40:1)	Normal Max. Min.	4000KW 5000 2500	4500KW 6000 3000	8000KW 10000 5000	12MW 15 7500KW	12MW 15 7500KW	15MW 20 10	30MW 40 20	35MW 50 25	50MW 60 30	100MW 150 75	250MW 300 150
RATIO 300/5 (60:1)	Normal Max. Min.	6000KW 8000 4000	7000KW 8000 4000	12MW 15 7.5	18MW 20 10	18MW 25 12.5	20MW 30 15	45MW 60 30	60MW 75 30	75MW 80 40	150MW 200 100	400MW 500 250
RATIO 400/5 (80:1)	Normal Max. Min.	8000KW 10MW 5000KW	10MW 12 6000KW	15MW 20 10	24MW 30 15	25MW 30 15	30MW 40 20	60MW 80 40	80MW 100 50	100MW 120 60	200MW 300 150	500MW 600 300
RATIO 600/5 (120:1)	Normal Max. Min.	12MW 15 7500KW	15MW 18 10	25MW 30 15	35MW 40 20	40MW 50 25	45MW 60 30	90MW 120 60	100MW 150 75	150MW 180 75	350MW 450 225	800KW 1000 500
RATIO 800/5 (160:1)	Normal Max. Min.	15MW 20 10	20MW 25 12.5	30MW 40 20	50MW 60 30	50MW 60 30	60MW 80 40	120MW 150 75	150MW 200 100	200MW 200 100	500MW 600 300	1000MW 1200 600
RATIO 1000/5 (200:1)	Normal Max. Min.	20MW 25 12.5	25MW 30 15	40MW 50 25	50MW 60 30	60MW 80 40	75MW 100 50	150MW 200 100	200MW 250 125	250MW 300 150	600MW 750 300	1200MW 1500 750
RATIO 1200/5 (240:1)	Normal Max. Min.	25MW 30 15	30MW 35 20	50MW 60 30	60MW 80 40	80MW 100 50	100MW 120 60	175MW 200 100	250MW 300 150	300MW 350 175	750MW 900 450	1500MW 2000 1000
RATIO 1500/5 (300:1)	Normal Max. Min.	30MW 40 20	35MW 40 20	60MW 80 40	75MW 100 50	100MW 120 60	120MW 150 75	250MW 300 150	300MW 350 175	350MW 450 225	900MW 1000 500	2000MW 2500 1250
RATIO 2000/5 (400:1)	Normal Max. Min.	40MW 50 25	50MW 60 30	80MW 100 50	100MW 150 75	120MW 150 75	150MW 200 100	300MW 400 200	400MW 500 250	500MW 600 300	1000MW 1500 750	2500MW 3000 1500
RATIO 3000/5 (600:1)	Normal Max. Min.	60MW 80 40	75MW 80 40	100MW 150 75	150MW 200 100	200MW 250 125	200MW 300 150	400MW 500 250	600MW 750 350	700MW 900 450	1500MW 2000 1000	3500MW 5000 2500
RATIO 4000/5 (800:1)	Normal Max. Min.	80MW 100 50	100MW 125 60	150MW 200 100	200MW 300 150	250MW 300 150	300MW 400 200	500MW 800 400	800MW 1000 500	1000MW 1200 600	2000MW 3000 1500	500MW 6000 3000
RATIO 5000/5 (1000:1)	Normal Max. Min.	100MW 120 60	125MW 150 75	200MW 250 125	250MW 300 150	300MW 400 200	400MW 500 250	750MW 1000 500	1000MW 1200 600	1200MW 1500 750	3000MW 3500 1750	3000MW 8000 4000
RATIO 6000/5 (1200:1)	Normal Max. Min.	120MW 150 75	150MW 175 80	250MW 300 150	350KW 400 200	400MW 500 250	450MW 600 300	1000MW 1200 600	1200MW 1500 750	1500MW 1750 800	3500MW 4000 2000	8000MW 10000 5000

AC VArmeters



PRODUCT CODES - ELEMENT, TRANSFORMER RATED, 50/60HZ
INTEGRAL TRANSDUCER - ACCURACY 1.0%, 50/60HZ

Phases	Wires	Amperes	1VA max. burden	Volts	1 VA max. burden	4 1/2" square flange		
						Scaling	Std. case catalogue number	Std. case hi-shock catalogue number
3	3	5	120V	To suit	•007-31LA-QQ**	-C7	078-31LJ-QQ**	-C6
3	3	5	208V	To suit	•007-31LA-QR**	-C7	078-31LJ-QR**	-C6
3	3	5	240V	To suit	•007-31LA-QS**	-C7	078-31LJ-QS**	-C6
3	3	5	380V	To suit	•007-31LA-QX**	-C7	078-31LJ-QX**	-C6
3	3	5	480V	To suit	•007-31LA-QT**	-C7	078-31LJ-QT**	-C6

For connection diagram refer to Figure D1 & D2.

PRODUCT CODES - 2 1/2-ELEMENT, TRANSFORMER RATED, 50/60HZ
TAUT BAND INTEGRAL TRANSDUCER - ACCURACY 1.0%, 50/60HZ

Phases	Wires	Amperes	1VA max. burden	Volts	1 VA max. burden	4 1/2" square flange		
						Scaling	Std. case catalogue number	Std. case hi-shock catalogue number
3	4	5	120V	To suit	•007-31UA-QQ**	-C7	078-31UJ-QQ**	-C6
3	4	5	208V	To suit	•007-31UA-QR**	-C7	078-31UJ-QR**	-C6
3	4	5	480V	To suit	•007-31UA-QT**	-C7	078-31UJ-QT**	-C6

For connection diagram refer to Figure D1 & D2.

- * Other scales are available.
- ** Specify CT (Current Transformer) and VT (Voltage Transformer) ratios if used and preferred scale at time of ordering.
- c-UL-us certified.

DC transducer indicators



PRODUCT CODES

Rating	Scaling*	4 1/2" square flange	
		Std. case catalogue number	Std. case hi-shock catalogue number
Watts 1mA	To suit	•007-055A-FA**	078-055J-FA**
VARs 1mA	To suit	•007-056A-FA**	078-056J-FA**
Frequency 1mA	To suit	•007-053A-FA**	078-053J-FA**
Power factor 1mA	To suit	•007-054A-FA**	078-054J-FA**
AC amps 1mA	To suit	•007-05AA-FA**	078-05AJ-FA**
AC volts 1mA	To suit	•007-05VA-FA**	078-05VJ-FA**
Speed 1mA	To suit	•007-052A-FA**	078-052J-FA**
VA 1mA	To suit	•007-057A-FA**	078-057J-FA**

Fig. D1 Models 007-31L VArmeter 3-phase 3-wire unbalanced load

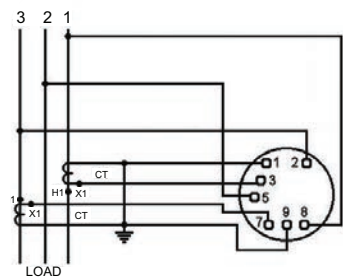
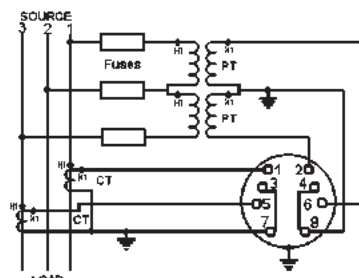

Fig. D2 Models 078-31L VArmeter 3-phase 3-wire unbalanced load



- * Case types 007/078 use 10-32 UNF terminals.
- ** Specify scale. Input: 1mA DC for 4/20mA change "FA" to "HG".
- c-UL-us certified.

For use with the following transducers: Watts, Vars, Frequency, Power Factor, AC amperes, AC volts and temperature.

007 synchroscope

FEATURES

- 2.5 degrees accuracy
- Enhanced safety
- ANSI C39.1
- Reliable



APPLICATIONS

- Switchgear
- Distribution systems
- Energy management
- Process control
- Building management

PANEL CUT OUT

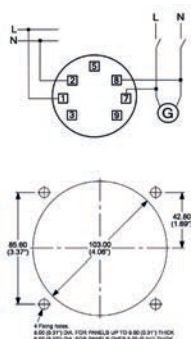

APPROVALS

- c-UL UL listed
File number E354483



BENEFITS

- Enhanced safety

The Crompton Instruments AC synchroscope measures and displays the frequency difference of two power sources. Monitoring the display allows the user to connect two synchronized AC power systems together. This can help prevent the potential damage caused by connecting two unsynchronized power sources.

The 4.50" meter complies with ANSI C39.1 specifications.

ACCESSORIES

The ANSI Switchboard AC Synchroscope also comes with a range of accessories to complement the product.

- Neoprene panel gasket
- Terminal cover

PRODUCT CODES

Model	Function
007-145A-PRAE-C5	120 V AC, 50 Hertz
007-146A-PRAE-C6	120 V AC, 60 Hertz
007-145A-RRAE-C5	240 V AC, 50 Hertz
007-146A-RRAE-C6	240 V AC, 60 Hertz
007-145A-SBAE-C5	415 V AC, 50 Hertz
007-146A-SBAE-C6	415 V AC, 60 Hertz

PRODUCT CODE AND ORDERING INFORMATION EXAMPLE

007-146A-PRAE-C6

SPECIFICATIONS

Rating, self-contained	120 V AC
Frequency rating	50 or 60 Hertz (specify)
Normal operating position	On vertical panel unless otherwise specified at time of order
Position influence	Not more than 3.6 mechanical degrees deviation for up to 60° tilt from normal operating position
Accuracy	2.5 degrees
Overshoot	33% maximum
Response time	3 seconds maximum for 180° deflection
Sensitivity at synchronism	3 electrical degrees maximum
Operating temperature range	3% maximum in 5 oersted field
Pull in frequency	58 Hz
Drop out frequency	57 Hz
Dielectric test	Live parts to case, including panel: 2600 V RMS for 1 minute
Between running and incoming circuits	1500 V RMS for 1 minute
Overload	1.15% of rated voltage
Operating Temperature	-10°C - +45°C
Humidity	25% - 80%
Relay Output	100 mA @ 120 V DC

DIMENSIONS

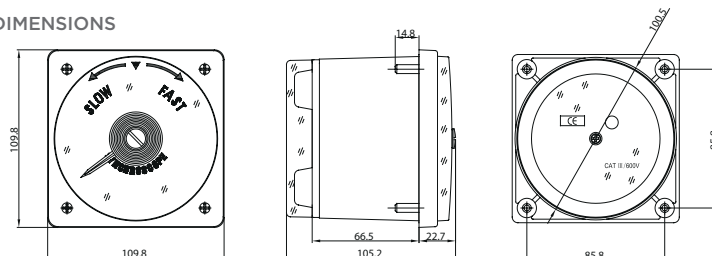

Elapsed time meters



PRODUCT CODES - 99,999.99 HOURS, NON RESET, BURDEN 2.5VA 50 OR 60HZ

Synchronous motor running time meter with a non-resettable indicator.

Rating	4 1/2" square flange	
	Std. case catalogue number	Std. case hi-shock catalogue number
110/130 V 50 Hz	•007-155A-PNZH-C5	078-155J-PNZH-C5
200/250 V 50 Hz	•007-155A-RNZH-C5	078-155J-RNZH-C5
480 V 50 Hz	•007-155A-SEZH-C5	078-155J-SEZH-C5
110/130 V 60 Hz	•007-156A-PNZH-C6	078-156J-PNZH-C6
200/250 V 60 Hz	•007-156A-RNZH-C6	078-156J-RNZH-C6
480 V 60 Hz	•007-156A-SEZH-C6	078-156J-SEZH-C6
12/24/40/110 V DC	007-151A-**-ZH-DC	Not Available

AC phase sequence, phase failure indicators



PRODUCT CODES - NEON BULB TYPE, BURDEN 2.5VA

Two neon bulbs for phase sequence indication - first marked the caption "correct 1-2-3", the second marked "incorrect 3-2-1". Three neon bulbs for phase failure indication - first marked 1, second marked 2, third marked 3.

Rating	4 1/2" square flange	
	Std. case catalogue number	Std. case hi-shock catalogue number
100/150 V 50/60 Hz	077-12PA-P2C6	Not available
151/300 V 50/60 Hz	077-12PA-P3C6	Not available
301/500 V 50/60 Hz	077-12PA-P4C6	Not available

For connection diagram refer to Figure E.

AC power factor meter



SPECIFICATIONS

Ratings, self-contained	Current windings 5 A. Voltage windings minimum 50 V, maximum 600 V
Accuracy	Balanced load: Class 1
Overshoot	33%
External temperature influence	0.5% fid minimum
External field influence	0.5% fid maximum
Frequency range	50 Hz or 60 Hz standard, 25-400 Hz optional (Specify)
Frequency influence	Single phase instruments, 59 to 61 Hz 1.0% fid maximum polyphase instruments $\pm 10\%$ deviation from 69 Hz: 1.0%
Overload capacity: 25% indefinitely	Current coils 1000% momentarily, 100% for 15 minutes Voltage circuits 25% indefinitely
Burdens	Each current circuit, 1.5VA approximately Each voltage circuit 1 VA approximately Measuring systems 077-427-3 or 4-wire
Ranges available	Lag 0.5-1 - 0.5 lead power factor Lag 0.2-1 - 0.8 lead power factor

Fig. E Models 007-425, 078-425J electronic phase angle meter single phase

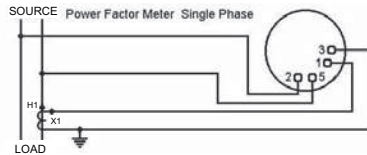
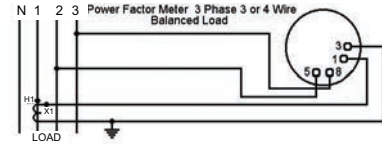

Fig. F Models 007-427, 078-427J electronic phase angle meter 3-phase, 3- or 4-wire balanced load



PRODUCT CODES - BALANCED LOAD - ACCURACY $\pm 1\%$

Measured System	Scaling	4 1/2" square flange	
		Std. case catalogue number	Std. case hi-shock catalogue number
Phases Wires Amperes 1VA max. burden Volts 1 VA max. burden			
1 2 5 120V	0.5-1-0.5	•007-425A-QQAD-C6	078-425J-QQAD-C6
1 2 5 240V	0.5-1-0.5	•007-425A-QSAD-C6	078-427J-QSAD-C6
3 3/4 5 120V	0.5-1-0.5	•007-427A-QQAD-C6	078-427J-QQAD-C6
3 3/4 5 208V	0.5-1-0.5	•007-427A-QRAD-C6	078-427J-QRAD-C6
3 3/4 5 240V	0.5-1-0.5	•007-427A-QSAD-C6	078-427J-QSAD-C6
3 3/4 5 480V	0.5-1-0.5	•007-427A-QTAD-C6	078-427J-QTAD-C6

* c-UL-us certified.



Instruments may be used on loads down to 20% of current and between 90% and 110% of voltage rating.

For connection diagrams refer to Fig. E and F.

LED digital | analog combination

FEATURES

- Rugged shock and vibration resistant pivot and jewel design
- High accuracy LED display
- Wide selection of AC and DC inputs
- Maximum trend indication visibility
- Input isolation
- External decimal point selection option
- Interchangeable with 4 ½" switchboard meters



APPLICATIONS

- Switchgear
- Distribution systems
- Generator sets
- Control panels
- Energy management
- Building management
- Utility power monitoring
- Process control
- Motor control

APPROVALS

- c-UL UL listed
- E203000
- CE marked



BENEFITS

- Cost effective
- Meets all the requirement of ANSI-C39.1 (1981)
- IP54 (NEMA 3) protection
- Optional IP55 (NEMA 4) gasket
- Bump, shock and vibration proof
- Customized option and features

Crompton Instruments model 007-DI features a combination of the traditional 250° 4 ½" switchboard indicator with the trend indication plus the benefits of wide angle LED visibility. This rugged shock and vibration resistant design provides precision accuracy and instantaneous reading via the bright in-dial mounted 3 ½" digit LED display.

DESCRIPTION

Model 007-DI digital analog indicators are ideal for all applications where moving pointer instruments are preferable to indicate trend with the simultaneous display of a high visibility precision LED readout for increased user interface.

The 007-DI is interchangeable with other analog and digital instruments designed to directly mount in to a standard ANSI-C39. 4 ½" switchboard cut-out. Available in side, centre, or off-set zero versions, the 007-DI can accept AC and DC current and voltage inputs as well as a wide range of transducer outputs, making it suitable for a variety of other applications including low-load current, temperature, speed, Watt/VARS, percent and level.

SPECIFICATIONS

Inputs	DC Voltage: 100 mV-600 V (1 M Ω input impedance as standard) DC Current: 1 mA-1 A, 4 to 20 mA (Voltage drop 200 mV nominal) External shunt operation (50mV and 100mV) AC Voltage: 200 mV-600 V (1 k Ω /volt) AC Current: 1 mA-999 mA (Using internal shunt, voltage drop 200mV nominal) 1 A, 2 A, 5 A and 10 A using internal current transformer
Common mode rejection	=>80 dB @ 50/60 Hz
Overload	Voltage: x 1.2 continuous. x 1.5 for 10 seconds Current using internal CT: x 1.2 continuous. x 10 for 10 seconds
External power requirement	Standard: 120 and 240 V \pm 15% Optional: 480 V \pm 15% AC 40-60 Hz
Burden	3 VA @ 60 Hz
DC	Standard: 12, 24, 48, 110 and 125 V \pm 15%
Display analog	Long-scale moving coil. 250° deflection. Scale length 6.8" Response time less than 2.5 seconds
Display options	Center or offset zero. Scale plate in colors other than white Colored lines or segments on scale
Digital display	3 ½ digit red LED. 7 segment (7.6 mm, 0.3" high). Right hand decimal points. Polarity indication: positive / none. Negative / horizontal bar " - ". Update time (standard): 1 per second
Accuracy - analog	DC and AC \pm 1% of FSD (calibrated at 25°C)
Accuracy - digital	DC: \pm 0.05% of reading \pm 1 count \pm 100 ppm of reading / °C max AC current: 0-1 Amp \pm 0.1% reading \pm 3 counts \pm 150 ppm of reading / °C AC current: 0-10 amps \pm 0.1% reading \pm 10 counts \pm 150 ppm of reading / °C (maximum) AC voltage: \pm 0.1% of reading \pm 3 counts \pm 150 ppm of reading / °C (maximum) Zero \pm 1 count \pm 0.2 counts/°C (maximum), DC offset scale only. Warm-up time: 1 minute
Long term stability	\pm 2 counts
Calibration check	Recommended 12 monthly intervals
Enclosure code	IP54 (optional IP55 using panel gasket)
Operational temperature	0 to 60°C (32° - 140° F)
Storage temperature	-20° to 60°C (-4° - 140° F)
Humidity	Up to 90% relative @ 55° C. Tests to BS2011 part 2DA
Isolation test voltage	2 kV RMS 60 Hz for 1 minute
Interference rejection	To IEEE STD472, ANSI C37 90A, SEN 361503, IEC 255-4

LED digital | analog combination

AC VOLTMETER



- * Other scalings are available.
- ** Specify power supply voltage according to power supply codes table located on page 73.
- *** Case types 007 use 10-32 UNF terminals.

PRODUCT CODES - 99,999.99 HOURS, NON RESET, BURDEN 2.5VA 50 OR 60HZ

Digital accuracy ±0.1% ±3 counts, analog accuracy ±1%

Rating	Scaling*	Catalogue number
200mV	0-200mV	007-DIWA-KAKA-C6-**
250mV	0-250mV	007-DIWA-KDKD-C6-**
500mV	0-500mV	007-DIWA-KMKM-C6-**
1V	0-1V	007-DIWA-LALA-C6-**
5V	0-5V	007-DIWA-LSLC-C6-**
10V	0-10V	007-DIWA-MTMT-C6-**
15V	0-15V	007-DIWA-NDND-C6-**
30V	0-30V	007-DIWA-NLNL-C6-**
150V	0-150V	007-DIWA-PZPZ-C6-**
250V	0-250V	007-DIWA-RSRS-C6-**
300V	0-300V	007-DIWA-RXRXC6-**
500V	0-500V	007-DIWA-SFSF-C6-**
600V	0-600V	007-DIWA-SJSJ-C6-**

For connection diagrams, refer to Figure H.

PRODUCT CODES - AC VOLTMETERS TRANSFORMER RATED (40/70HZ)***

Rating	Scaling*	Catalogue number
150V	0-300V	007-DIWA-PZRX-C6-**
150V	0-600V	007-DIWA-PZSJ-C6-**
150V	0-750V	007-DIWA-PZSM-C6-**
150V	0-3000V	007-DIWA-PZUA-C6-**
143V	0-5000V	007-DIWA-PTUJ-C6-**
150V	0-5250V	007-DIWA-PZUL-C6-**
150V	0-6000V	007-DIWA-PZUP-C6-**
150V	0-9000V	007-DIWA-PZUY-C6-**
150V	0-15kV	007-DIWA-PZWC-C6-**
150V	0-18kV	007-DIWA-PZWD-C6-**
150V	0-45kV	007-DIWA-PZWJ-C6-**
150V	0-60kV	007-DIWA-PZWL-C6-**

For connection diagrams, refer to Figure H.

Fig. G Models 007-DA2, 007-DAA
LCD digital/analog meter

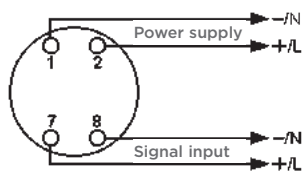
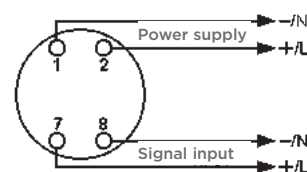

Fig. H Models 007-DI2, 007-DIA, 007-DIB, 007-DIC, 007-DIN, 007-DIT, 007-DIV, 007-DIW
LED digital/analog meter



LED digital | analog combination

AC AMMETER



- * Other scalings are available.
- ** Specify power supply voltage according to power supply codes table located on page 73.
- *** Case types 007 use 10-32 UNF terminals.

PRODUCT CODES - AC AMMETERS - DIRECT READING (40/70HZ)**

Rating	Scaling*	Catalogue number
1A	0-1A	007-DIBA-LALA-C6-**
1.5A	0-1.5A	007-DIBA-LCLC-C6-**
2A	0-2A	007-DIBA-LELE-C6-**
3A	0-3A	007-DIBA-LJLJ-C6-**
5A	0-5A	007-DIBA-LSLS-C6-**
8A	0-8A	007-DIBA-MJMJ-C6-**
10A	0-10A	007-DIBA-MTMT-C6-**

For connection diagrams, refer to Figure I.

FIG. I MODELS 007-DI2, 007-DIA
007-DIB, 007-DIC, 007-DIN, 007-DIT, 007-DIV, 007-DIW
LED DIGITAL /ANALOG METER

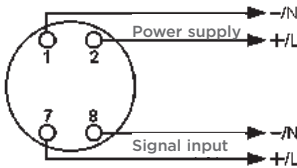

PRODUCT CODES - NEON BULB TYPE, BURDEN 2.5VA

Two neon bulbs for phase sequence indication - first marked the caption "correct 1-2-3", the second marked "incorrect 3-2-1". Three neon bulbs for phase failure indication - first marked 1, second marked 2, third marked 3.

PRODUCT CODES - AC AMMETERS TRANSFORMER RATED (40/70HZ)

Digital accuracy $\pm 0.1\% \pm 1$ counts, analog accuracy $\pm 1\%$

Rating	Scaling*	Catalogue number
5A	0-15A	007-DIBA-LSND-C6-**
5A	0-20A	007-DIBA-LSNG-C6-**
5A	0-25A	007-DIBA-LSNJ-C6-**
5A	0-30A	007-DIBA-LSNL-C6-**
5A	0-40A	007-DIBA-LSNP-C6-**
5A	0-50A	007-DIBA-LSNT-C6-**
5A	0-60A	007-DIBA-LSNW-C6-**
5A	0-75A	007-DIBA-LSPB-C6-**
5A	0-80A	007-DIBA-LSPD-C6-**
5A	0-100A	007-DIBA-LSPK-C6-**
5A	0-150A	007-DIBA-LSPZ-C6-**
5A	0-200A	007-DIBA-LSRL-C6-**
5A	0-250A	007-DIBA-LSRS-C6-**
5A	0-300A	007-DIBA-LSRX-C6-**
5A	0-400A	007-DIBA-LSSC-C6-**
5A	0-500A	007-DIBA-LSSF-C6-**
5A	0-600A	007-DIBA-LSSJ-C6-**
5A	0-750A	007-DIBA-LSSM-C6-**
5A	0-800A	007-DIBA-LSSN-C6-**
5A	0-1000A	007-DIBA-LSSS-C6-**
5A	0-1200A	007-DIBA-LSSU-C6-**
5A	0-1500A	007-DIBA-LSTC-C6-**

For connection diagrams, refer to Figure J.

FIG. J MODELS 007-DI2, 007-DIA
007-DIB, 007-DIC, 007-DIN, 007-DIT, 007-DIV, 007-DIW
LED DIGITAL/ANALOG METER

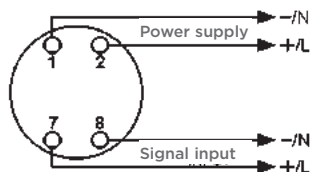

- * Other scalings are available.
- ** Specify power supply voltage, according to power supply codes table located on page 73.

LED digital | analog combination

DC VOLTMETER



PRODUCT CODES – DC VOLTMETERS - DIRECT READING

Digital accuracy $\pm 0.5\%$ ± 1 counts, analog accuracy $\pm 1\%$

Rating	Scaling*	Catalogue number
200mV	0-200mV	007-DIVA-KAKA-**
250mV	0-250mV	007-DIVA-KDKD-**
500mV	0-500mV	007-DIVA-KMKM-**
1V	0-1V	007-DIVA-LALA-**
5V	0-5V	007-DIVA-LSLS-**
10V	0-10V	007-DIVA-MTMT-**
15V	0-15V	007-DIVA-NDND-**
30V	0-30V	007-DIVA-NLNL-**
50V	0-50V	007-DIVA-NTNT-**
75V	0-75V	007-DIVA-PBPB-**
80V	0-80V	007-DIVA-PDPD-**
150V	0-150V	007-DIVA-PZPZ-**
300V	0-300V	007-DIVA-RXR X-**
400V	0-400V	007-DIVA-SCSC-**
500V	0-500V	007-DIVA-SFSF-**
600V	0-600V	007-DIVA-SJSJ-**
150-0-150V	150-0-150V	007-DINA-RXR X-**
300-0-300V	300-0-300V	007-DINA-SJSJ-**
600-0-600V	600-0-600V	007-DINA-SUSU-**

For connection diagrams, refer to Figure K.

FIG. K MODELS 007-DI2, 007-DIA
007-DIB, 007-DIC, 007-DIN,
007-DIT, 007-DIV, 007-DIW
LED DIGITAL/ANALOG METER

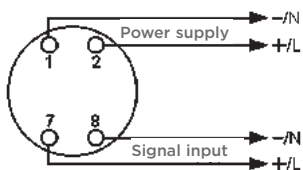

- * Other scalings are available.
- ** Specify power supply voltage, according to power supply codes table located on page 73.

LED digital | analog combination

DC AMMETER



- * Other scalings are available.
- ** Specify power supply voltage, according to power supply codes table located on page 73.

FIG. L MODELS 007-DI2, 007-DIA, 007-DIB, 007-DIC, 007-DIN, 007-DIT, 007-DIV, 007-DIW LED DIGITAL/ANALOG METER

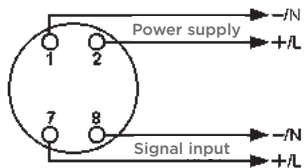

PRODUCT CODES - DC AMMETERS - SHUNT RATED

Digital accuracy $\pm 0.5\%$ ± 1 counts, analog accuracy $\pm 1\%$

Rating	Scaling*	Catalogue number
100-0-100mV	Scaled to suit standard shunt ratings	007-DICA-GM**.**
100-0-100mV-2-0-2mA		007-DICA-FM**.**

For connection diagram, refer to Figure L.

PRODUCT CODES - DC AMMETERS - SUPPRESSED ZERO

Digital accuracy $\pm 0.5\%$ ± 1 counts, analog accuracy $\pm 1\%$

Rating	Scaling*	Catalogue number
1-5mA	Scaled to suit standard shunt ratings	007-DIAA-GM**.**
4-20mA		007-DIAA-HG**.**
10-50mA		007-DIAA-HZ**.**

For connection diagram, refer to Figure L.

PRODUCT CODES - DC AMMETERS - DIRECT READING

Digital accuracy $\pm 0.5\%$ ± 1 counts, analog accuracy $\pm 1\%$

Rating	Scaling*	Catalogue number
1mA	0-1mA	007-DIAA-FAFA-**
2mA	0-2mA	007-DIAA-FGFG-**
5mA	0-5mA	007-DIAA-FXFY-**
10mA	0-10mA	007-DIAA-GZGZ-**
20mA	0-20mA	007-DIAA-HFHF-**
30mA	0-30mA	007-DIAA-HMHM-**
50mA	0-50mA	007-DIAA-HYHY-**
100mA	0-100mA	007-DIAA-JRJR-**
200mA	0-200mA	007-DIAA-KAKA-**
300mA	0-300mA	007-DIAA-KGKG-**
500mA	0-500mA	007-DIAA-KMKM-**
800mA	0-800mA	007-DIAA-KWKW-**
1A	0-1A	007-DIAA-LALA-**

For connection diagram, refer to Figure L.

Switchboard meter options

PRODUCT CODES - POWER SUPPLY

Power Supplies	
A2 - 12 - 48V DC	NR - 48V DC
A5-120 - 250V AC/DC	MU - 12V DC

SCALE - OPTIONS

Options	Option code
Red or colored line or mark (specify position)	SL
Colored zones or segments (specify limits and color(s))	SZ
Customer user logo imprinted on dial	SM

CONSTRUCTION - OPTIONS

Options	Option code
Anti-glare window	BR
Polychloroprene panel gasket	MG

The suffix option code is added at the end of the complete part number.

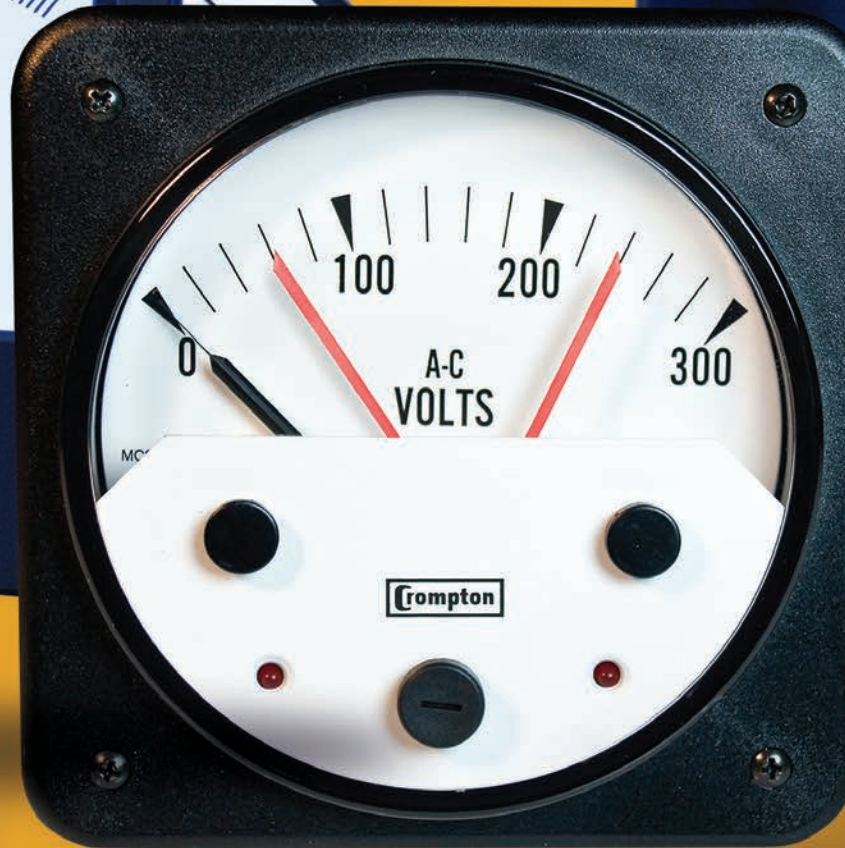



Chapter 6 Meter relay panel meters

239 Meter relay panel meters.....	80
244 Meter relay panel meters.....	81
007 Meter relay panel meters.....	83

239 Meter relay panel meters

FEATURES

- Class 1.5 Accuracy
- Stable electronic switching circuit does not use lamps, photocells, inductors or capacitors
- Isolated input signal
- Control function continues if the indicator becomes damaged
- Rugged, shock and vibration resistant design
- LED relay status indicators



APPLICATIONS

- Liquid level control
- Load shedding
- Power factor correction
- High & Low alarms
- Shutdown
- Frequency monitoring
- Temperature indication and control

DIMENSIONS

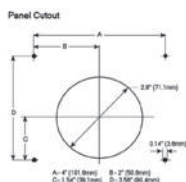
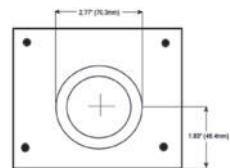
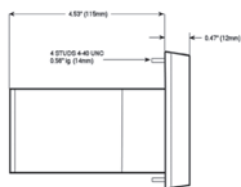
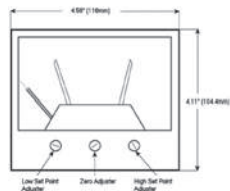

Series 239 meter relays combine a highly accurate indicator with High and Low set point relays. The relays can operate alarm and control devices when the monitored signal value moves outside the chosen set point limits shown by adjustable red index pointers. A single compact case houses the unit which requires only the input signal and power supply thus saving space and installation time.

PRODUCT CODES

Model	No. Relays & Setpoints	Function
239-300A	One relay, two setpoints	Upscale de-energized, downscale energized
239-301A	One relay, one setpoint	Upscale energized, downscale de-energized
239-302A	Two relays, two setpoints	Mid band de-energized, outside band energized
239-303A	Two relays, two setpoints	Both upscale energized, downscale de-energized
239-304A	Two relays, two setpoints	High and low midband energized, outside band de-energized – no time delay
239-305A	Two relays, two setpoints	Both upscale de-energized, downscale energized
239-307A	One relay, one setpoint	Upscale de-energized, downscale energized
239-30RA	Two relays, two setpoints	Midband de-energized, outside band energized – operates from 2, 3 or 4 wire RTD
239-30TA	Two relays, two setpoints	Midband de-energized, outside band energized – operates from thermocouple input

SPECIFICATIONS

Adjustments	
Front panel	Set-point potentiometer(s)
Rear panel	Delay potentiometer(s)
Measuring Inputs	
AC Voltage	10 V to 600 V RMS (Sensitivity 1 Kohm/V to 100 Kohm/V, max 2.5 Mohm)
AC Current	1 mA to 15 A RMS (20mV drop)
DC Voltage	10 mV to 600 V RMS (Sensitivity 1 Kohm/V to 100 Kohm/V)
DC Current	100 uA to 15 A (20 mV drop) Center zero option up to 15/015 amps
Max continuous input voltage	1.2x rating (600 V max.)
Max continuous input current	1.2x nominal (15 A max.)
Max short duration input current	6x nominal for 6 sec. (30 A max.)
Freq. monitoring	50 to 60 Hz +/-10%
Burden	<0.5 VA
Damping Time	1 second
4" Scale	100 deg. Deflection
Panel Material	
Panel Material	Ferrous or non-ferrous
Dielectric Test	2600 V RMS for 1 min.
Auxiliary Supply Burden	<1.5 W
Enclosure	
Flammability	UL94V1
Terminal capacities	1 to 4 mm ² solid or stranded conductors
Accuracy	
Indicator accuracy	Class 1.5
Set-point range	98% of scale
Set-point accuracy	1% of range
Set-point hysteresis	2% of range
Trip repeatability	0.5% of range
Relay trip-time	<1 second
Time delay	0-20 seconds, adjustable by potentiometer on rear panel. Option: 0-10 sec & 0-40 sec.
Indication	Single red LED, per set-point, to indicate trip condition
Outputs	
Relays	DPCO contacts rated 5 A @ 250 V AC; 5 A @ 30 V DC. Resistive electrical life >100,000 operations @ 5 A, 250 V AC Contact class IIB (IEC 60255-0-20)
Relay logic	Configurable to energize or de-energize on trip
Environmental & Mechanical	
Ambient temperature reference range	+15 deg C to +30 deg C
nominal range of use	0 deg C to +60 deg C
Storage temperature	-20 deg C to +70 deg C
Relative humidity	<90%, non condensing
Shock	15g/6ms (EN 60068-2-27)
Bumping	40g/6ms (EN 60058-2-29)
Vibration	10-300Hz (EN 60068-2-6)
Protection Class	Terminals to IP20
BS EN 60529)	Enclosure to IP50

244 Meter relay panel meters

FEATURES

- Class 1.5 Accuracy
- Isolated input signal
- LED relay status indicators
- Isolated input signal



APPROVALS

- CE Approved

Series 244 meter relays combine a highly accurate indicator with High and Low set point relays. The relays can operate alarm and control devices when the monitored signal value moves outside the chosen set point limits shown by adjustable red index pointers. A single compact case houses the unit which requires only the input signal and power supply thus saving space and installation time.

PRODUCT CODES

Model	No. Relays & Setpoints	Function
M244-302A	Two relays, two setpoints	Mid band de-energized, outside band energized
M244-30RA	Two relays, two setpoints	Midband de-energized, outside band energized – operates from 2, 3 or 4 wire RTD
M244-30TA	Two relays, two setpoints	Midband de-energized, outside band energized – operates from thermocouple input

SPECIFICATIONS

Measuring Inputs	
DC Voltage	40 to 800 mV, 1 to 60 V, 100 to 600 V
DC Current	25 to 600 μ A, 1 to 60 mA, 1 to 5A
AC Voltage	40 to 800 mV, 1 to 60 V, 100 to 600 V
AC Current	1 to 6 mA, 100 to 600 mA, 1 to 5A
Frequency	45 to 55 Hz, 48 to 52 Hz, 45 to 65 Hz, 55 to 65 Hz
Thermocouple (J, K, S)	0 to 250 °C, 0 to 600 °C, 0 to 1200 °C, 0 to 600 °C
Temperature Dependent Resistor (Pt 100)	- 200 to + 800 °C
Outputs	
Switching element	Potential free alternative relay contacts. Switching power at resistive load: \leq 600 VA (3 A, \leq 250 V)
Output Channel I	Adjustable by MIN limit value
Output Channel II	Adjustable by MAX limit value
Relay Characteristics	
Adjustments elements on rear panel	Range of limit value adjusting (MIN, MAX) 0 to 100% F.S.D.
Setting accuracy	\pm 5 % (25 to 75 %), \pm 15 % (0 to 25 %, 75 to 100 %)
Setting reproducibility	< 2 %
Hysteresis	< 1 % F.S.D
Delay time adjusting range	0.5 to 30 s
Setting accuracy	\pm 20 % \pm 2 s
Setting reproducibility	< 2 %
Supply	
Input	110/230 V \pm 10 % 45 to 65 Hz or 24 V DC
Power consumption	2 VA
Environmental	
Operating temperature	0 to 55 °C
Storage temperature	-20 to 60 °C
Relative humidity	\leq 75 % yearly average, no condensation
Enclosure	
Material	Flame retardant plastic (UL94V-0)
Dimensions	Front dimension: 96 mm x 96 mm, panel cut-out: 92 mm x 92 mm, installation depth: max 120 mm
Screw Connector	Up to 2.5 mm ²
Mounting	Fixing element to panel
Weight	0.6 kg

APPLICATIONS

- Liquid level control
- Load Shedding
- Power factor correction
- High and low alarms
- Shutdown
- Frequency monitoring
- Temperature indication and control

244 Meter relay panel meters

SPECIFICATIONS

Protection	Corresponding to DIN 40 050
Housing	IP52
Connector	IP00
Safety	Class II in accordance to IEC 348, DIN 57411

WIRING DIAGRAMS

AC/DC VOLTAGE METER

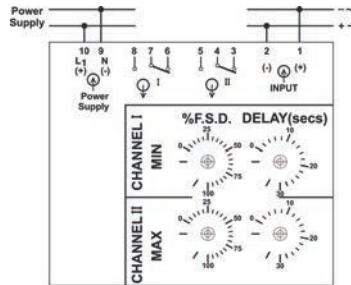

AC/DC CURRENT METER

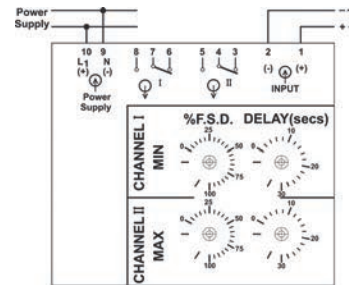

FREQUENCY METER

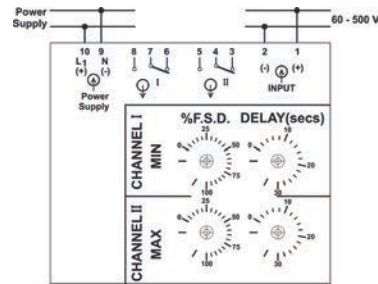

THERMOMETER WITH THERMOCOUPLE

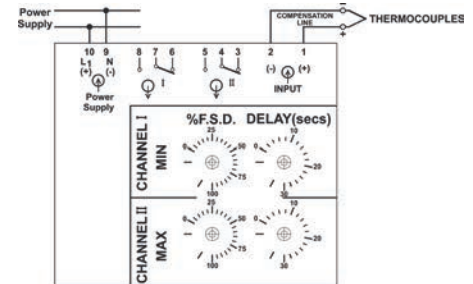

THERMOMETER WITH PT100 PROBE

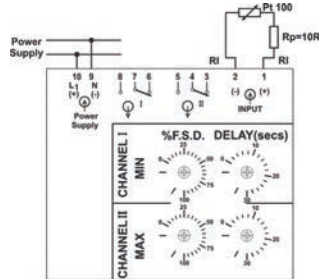

Pt 100 (RTD probe)
 Rp = wires resistively compensation resistor:
 built-in potentiometer
 RI = wires resistively
 $R_p + R_I = 10 \Omega$

DIMENSIONS

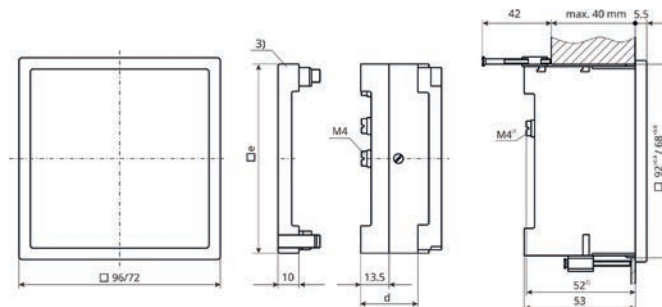

Series 007 switchboard analog meter relays

FEATURES

- Indicator Class 1.5 Accuracy
- Stable electronic switching circuit does not use lamps, photocells, inductors or capacitors
- Isolated input signal
- Control function continues if the indicator becomes damaged
- Rugged, shock and vibration resistant design
- LED relay status indicators



APPLICATIONS

- Level control
- Load shedding
- Power factor correction
- High & Low alarms
- Shutdown
- Overload alarm
- Temperature indication and control

Series 007 Meter Relays combine a highly accurate indicator with High and Low set point relays. The relays can operate alarm and control devices when the monitored signal value moves outside the chosen set point limits shown by adjustable red index pointers.

A single compact case houses the unit which requires only the input signal and power supply thus saving space and installation time.

ACCESSORIES

The following optional accessories are also available for the 239 Meter Relay:

- Relay latching
- External reset switch
- Finger knob setpoint adjusters
- Hysteresis
- Panel mounting gasket

PRODUCT CODES

Model	No. Relays & Setpoints	Function
007-300A	One relay, two setpoints	Upscale de-energized, down scale energized
007-301A	One relay, one setpoint	Upscale energized, downscale de-energized
007-302A	Two relays, two setpoints	Mid band de-energized, outside band energized
007-303A	Two relays, two setpoints	Both upscale energized, downscale de-energized
007-304A	Two relays, two setpoints	High and low midband energized, outside band de-energized – no time delay
007-305A	Two relays, two setpoints	Both upscale de-energized, downscale energized
007-307A	One relay, one setpoint	Upscale de-energized, downscale energized
007-30RA	Two relays, two setpoints	Midband de-energized, outside band energized – operates from 2, 3 or 4 wire RTD
007-30TA	Two relays, two setpoints	Midband de-energized, outside band energized – operates from thermocouple input

For complete ordering codes, including input, scaling and auxiliary ratings, please consult your sales representative.

DIMENSIONS

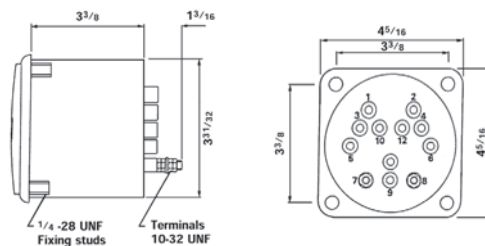

CONNECTIONS

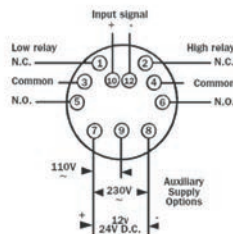
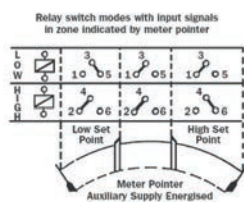





Chapter 7 Sealed and ruggedized panel indicators

Sealed and ruggedized panel indicators.....86

Sealed and ruggedized panel indicators

FEATURES

- Designed specifically for stringent industrial, marine and military specifications
- An extensive range of high accuracy measuring instruments in 3 case sizes
- Rugged Hi-Q taut-band suspension
- Bump, shock and vibration proof



APPLICATIONS

- Switchgear
- Distribution systems
- Generator sets
- Control panels
- Utility power monitoring
- Process control
- Motor control
- Marine
- Military

APPROVALS

- DEF STAN 66.7

BENEFITS

- Complies with BS EN60051 (IEC51)
- IP67 (NEMA 6 and 6P) protection
- Dial illumination option
- Parallax error-free platform dials for 078/087. Optional for 083/084

078/080/087 SERIES 240° SCALE

The Crompton Instruments 078/080/087 series of heavy duty sealed instruments are designed to comply with the most stringent industrial, marine and military specifications.

This metal cased range offers bezel sizes of 57 mm, 83 mm and 110 mm all fitted with toughened glass. Indicators comply with Ministry of Defence specification DEF STAN 66.7. and operate efficiently in the most adverse environments where extreme conditions of shock, vibration, dirt, humidity and temperature variation are present.

DESCRIPTION

Indicators have metal cases with bezel sizes of 50 x 57 mm (083), 83 mm Ø (084) and 110 mm x 100 mm (078/087). All indicators are fitted with toughened glass windows. The standard black matt finish can be replaced with options ranging from light admiralty grey to BS3181C No:697. To prevent fogging, all indicators have been dried, evacuated and filled with dry nitrogen during manufacturing. The case interior retains a constant pressure of at least 94kPa above the exterior with leakage not above the equivalent of 1.33 Pa ml/s of air. Except on model 083, panel sealing gaskets are standard equipment.

Standard instrument dials are finished in acrylic white matt with black printing and a parallel pointer. Scales form a true arc with zero on the left hand-side. Options include dial illumination, a centre, off-set or suppressed zero, analog index lines, bands, zones or segments, a black dial with white printing, and customer *logo*.

SPECIFICATIONS

Performance	BS EN60051 (IEC51) DEF STAN 66-7 on request (087 only)
Accuracy	Refer to Product Range table
Scaling	BS89, BS3693 or DEF STAN 66-7 and 66-9
Dielectric test	2kV RMS to BS EN61010-1
Overloads	x 1.2 rated current for 2 hours x 10 rated current for 5 seconds x 1.2 rated voltage for 2 hours x 2 rated voltage for 5 seconds
Enclosure code	IP67 (NEMA 6 and 6P)
Case	Black matt metal filled with dry nitrogen
Bezel	Black matt metal. Optional admiralty gray No. 697
Bezel window	Toughened glass
Operating temperature	-40°C to +70°C (-40°F to +158°F)
Storage temperature	-55°C to +85°C (-67°F to +185°F)
Standard calibration	23°C (73°F)
Approvals	EMC and LVD DEF 66.7

Sealed and ruggedized panel indicators

078/080/087 SERIES 240° SCALE

PRODUCT RANGE

Type of instrument	Ranges	Accuracy class	Burden VA	Case code depth behind the bezel				Product code
DC ammeter shunt operated	50, 60, 75, 100, 150 mV	2.5	See T118***	57	-	-	-	083-05A
DC ammeter shunt operated	50, 60, 75, 100, 150 mV	1.5	See T118***	-	59	-	-	084-05A
DC ammeter shunt operated	50, 60, 75, 100, 150 mV	1.5	See T118***	-	-	86	-	078-05A
DC ammeter shunt operated	50, 60, 75, 100, 150 mV	1.5	See T118***	-	-	-	86	087-11A
DC ammeter	200 µA-30 A	2.5	See T118***	57	-	-	-	083-05A
DC ammeter	200 µA-30 A	1.5	See T118***	-	59	-	-	084-05A
DC ammeter	200 µA-30 A	1.0	See T118***	-	-	86	-	078-05A
DC ammeter	200 µA-30 A	1.0	See T118***	-	-	-	86	087-11A
DC ammeter suppressed zero	4/20 mA	2.5	See T118***	57	-	-	-	083-05R
DC ammeter suppressed zero	4/20 mA	1.5	See T118***	-	59	-	-	084-05R
DC ammeter suppressed zero	4/20 mA	1.5	See T118***	-	-	86	-	078-05R
DC ammeter suppressed zero	4/20 mA	1.5	See T118***	-	-	-	86	087-11R
DC voltmeter	50 mV-600 V	2.5	See T118***	57	-	-	-	083-05V
DC voltmeter	50 mV-600 V	1.5	See T118***	-	59	-	-	084-05V
DC voltmeter	50 mV-800 V	1.5	See T118***	-	-	86	-	078-05V
DC voltmeter	50 mV-800 V	1.0	See T118***	-	-	-	86	087-11V
DC voltmeter suppressed zero	1/5 V	1.5	See T118***	-	-	86	-	078-05S
DC voltmeter suppressed zero	1/5 V	1.5	See T118***	-	-	-	86	087-11S
AC rectified ammeter	200 µA-1 A	2.5	See T118***	57	-	-	-	083-05B
AC rectified ammeter	200 µA-1 A	2.5	See T118***	-	59	-	-	084-05B
AC rectified ammeter	200 µA-30 A	1.5	See T118***	-	-	86	-	078-05B
AC rectified ammeter	200 µA-30 A	1.5	See T118***	-	-	-	86	087-11B
AC rectified voltmeter	15 - 600 V 25 Hz/3 kHz	2.5	See T118***	57	-	-	-	083-05W
AC rectified voltmeter	15 - 600 V 25 Hz/3 kHz	2.5	See T118***	-	59	-	-	084-05W
AC rectified voltmeter	15 - 600 V 25 Hz/3 kHz	1.5	See T118***	-	-	86	-	078-05W
AC rectified voltmeter	15 - 600 V 25 Hz/3 kHz	1.5	See T118***	-	-	-	86	087-11W
Elapsed time meter	50 or 60 Hz, 100-400 V*			57	-	-	-	083-155 or 156
Elapsed time meter	12, 24 V DC			57	-	-	-	083-151
Elapsed time meter	50 or 60 Hz, 100-400 V*			-	59	-	-	084-155 or 156
Elapsed time meter	12, 24 V DC			-	59	-	-	084-151
Elapsed time meter	50 or 60 Hz, 100-400 V*			-	-	86	-	078-155 or 156
Frequency meter	50/60/400 Hz 100-440 V*	0.5%	4	57	-	-	-	083-41S
Frequency meter	50/60/400 Hz 100-440 V*	0.5%	4	-	59	-	-	084-41S/089-41S
Frequency meter	50/60/400 Hz 100-440 V*	0.5%	4	-	-	86	86	078/087-41L
Temperature indicator	RTD	1.5	See T118***	-	-	86	-	078-45 R
Wattmeter or Varmeter	0.2 - 10 A/100-440 V*	Balanced	Current	-	-	132	132	078/087-21 or 31
Transducer operated indicator	1, 5, 10, 20 or 4/20 mA	1.0	See T118***	57	-	-	-	083-05
Transducer operated indicator	1, 5, 10, 20 or 4/20 mA	1.0	See T118***	-	59	-	-	084-05
Transducer operated indicator	1, 5, 10, 20 or 4/20 mA	1.0	See T118***	-	-	86	-	078-05
Transducer operated indicator	1, 5, 10, 20 or 4/20 mA	1.0	See T118***	-	-	-	86	087-11

* 100 - 440 V = (100/125, 200/250, 380/440).

*** The T118 technical sheet is available on request.

Sealed and ruggedized panel indicators



080 SERIES 90° SCALE

A range of metal case, sealed instruments for industrial and military applications involving extreme shock, vibration, temperature, dirt and humidity. Bezel sizes 57 mm, 83 mm comply with Ministry of Defence specification DEF STAN 66-7 or DEF STAN 66-9 for all standard ratings.

DESCRIPTION

Two bezel sizes of 57 x 57 mm (O83) and 83 mm Ø (O84), with barrel diameters of 53 mm (O83) and 67 mm (O84) and toughened glass windows are used throughout the series. To avoid fogging they are dried, evacuated and filled with dry nitrogen. Panel sealing gaskets are provided as standard with the exception of Model O83. Models O83 and O84 have steel cases with fixing holes in the flange. Sealed zero adjusters are provided. Standard instrument dials are finished in a white matt with black printing and parallel pointer. The scales form a true arc with zero on the left.

OPTIONS

Available options include dial illumination, a centre, off-set or suppressed zero, color index lines, bands, zones or segments, a black dial with white printing and customer logo. Instruments operated by separate transducers indicate watts, VAR, frequency, phase angle, current, voltage and other physical/mechanical parameters are also available. Illumination options as follows:

Models O83/O84: Edge, white or red bulb, 12 or 24 V, illumination.

SPECIFICATIONS

Performance	BS EN60051 (IEC51). DEF STAN 66-7 and 66.9 on request (O84 only)
Accuracy	Class 2.5 frequency meter 0.5% of mid frequency
Scaling	To BS89, BS3693 or DEF STAN 66-7 and 66-9
Dielectric test @ 50 Hz	2 kV RMS; <50 V 500 V RMS All for 1 minute
Overloads	x1.2 rated current or voltage for 2 hours. x 10 rated current for 5 seconds. x2 rated voltage for 5 seconds
Burden	AC ammeter: 1 VA maximum. AC voltmeter: 3 VA maximum
Frequency meter	4 VA maximum
Elapsed time meter	2.5 VA maximum
Enclosure code	IP67 (NEMA 6 and 6P)
Case	Black matt metal filled with dry nitrogen
Bezel	Black matt metal
Bezel window	Toughened glass
Operating temperature	-40°C to +70°C (-45F to +158°F)
Standard calibration	23°C (73°F)
Approvals	EMC and LVD. DEF 66.7 and 66.9

PRODUCT RANGE

Type of instrument	Ranges	Accuracy class	Burden VA	Depth	Diameter	Dimension	Product code
AC ammeter moving iron	1 - 30 A	2.5	1.0	37.6	53		083-75A
AC ammeter moving iron	1 - 30 A	2.5	1.0	38	67		084-75A
AC voltmeter moving iron	5 - 300 V	2.5	3.0	37.6	53		083-75V
AC voltmeter moving iron	5 - 300 V	2.5	3.0	38	67		084-75V
DC ammeter shunt operated	50, 60, 75, 100, 150 mV	2.5	1.0	33.6	53		083-80A
DC ammeter shunt operated	50, 60, 75, 100, 150 mV	2.5	1.0	33.5	67		084-80A
DC ammeter	50 µA-30 A	2.5	1.0	33.6	53		083-80A
DC ammeter	50 µA-30 A	2.5	1.0	33.5	67		084-80A
DC ammeter suppressed zero	4/20 mA	2.5	1.0	33.6	53		083-80R
DC ammeter suppressed zero	4/20 mA	2.5	1.0	33.5	67		084-80R
DC voltmeter	50 mV-300 V, 1000 Ω/V	2.5	2.0	33.6	53		083-80V
DC voltmeter	50 mV-300 V	2.5	2.0	33.5	67		084-80V
DC voltmeter suppressed zero	1/5 V	2.5	2.0	33.5	67		084-80S
AC rectified ammeter	100 µA-500 mA.25 Hz/3 kHz	2.5	3.0	33.6	53		083-80B
AC rectified ammeter	100 µA-500 mA.25 Hz/3 kHz	2.5	3.0	33.5	67		084-80B
AC rectified voltmeter	15 - 600 V, 900 Ω/V	2.5	3.0	33.6	53		083-80W
AC rectified voltmeter	15 - 600 V	2.5	3.0	33.5	67		084-80W
Elapsed time meter (99999.9)	12 or 24 V DC	2.5	3.0	33	53 / 67		082/083/084-151
Elapsed time meter (99999.9)	50 Hz/100-440 V*	2.5	2.5	33	53 / 67		083/084-155
Elapsed time meter (99999.9)	60 Hz/100-440 V*	2.5	2.5	33	53 / 67		083/084-156
Frequency meter	50 or 60 or 400 Hz/100-440 V*	2.5	4.0	33.6	53		083-41S
Frequency meter	50 or 60 or 400 Hz/100-440 V*	2.5	4.0	33.5	67		084-41S
Transducer indicator speed	1, 5, 10, 20, and 4/20 mA	2.5	1.0	33.5	67		084-802
Transducer indicator frequency	1, 5, 10, 20, and 4/20 mA	2.5	1.0	33.5	67		084-803
Transducer indicator phase angle	1, 5, 10, 20, and 4/20 mA	2.5	1.0	33.5	67		084-804
Transducer indicator watts	1, 5, 10, 20, and 4/20 mA	2.5	1.0	33.5	67		084-805
Transducer indicator VARs	1, 5, 10, 20, and 4/20 mA	2.5	1.0	33.5	67		084-806
Transducer indicator VA	1, 5, 10, 20, and 4/20 mA	2.5	1.0	33.5	67		084-807

*100-440V - (100/125 or 200/250 or 380/440).

Sealed and ruggedized panel indicators



DIMENSIONS Model 083

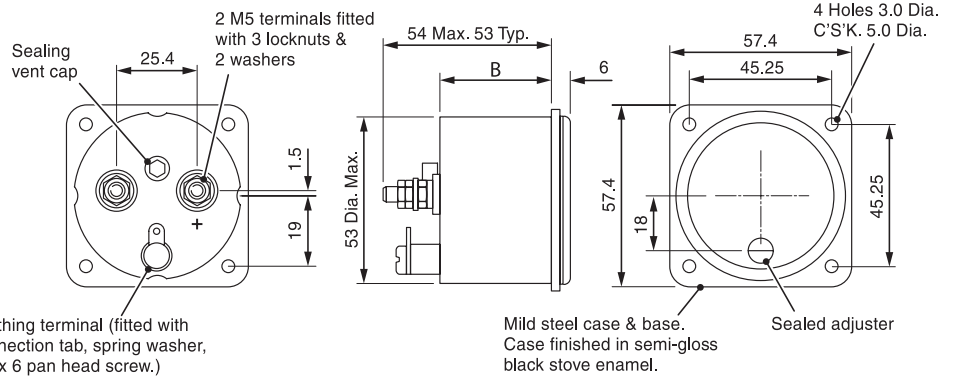

	B
083-80	33.6
083-75	37.6



Model 084

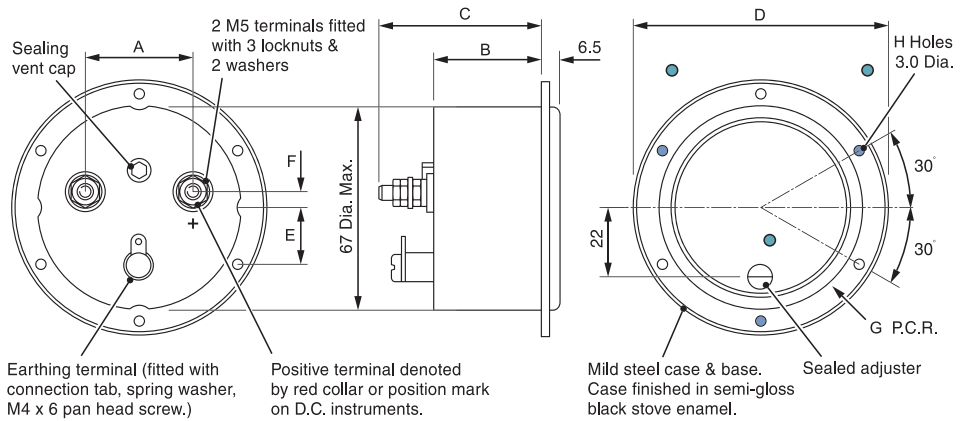

*When fitted with terminal shunt for ranges above 20 amps.

	A	B	C	D	E	F	G	H
084-80	35	33.5	59	82.5	20	5	36.5	6 off
084-75	35	38	64	82.5	20	5	36.5	6 off

Panel Cut out 68.3ø - Holes 3.8ø
These ● holes on 084 only.





Chapter 8 Instrument selector switches

Instrument selector switches.....92

Instrument selector switches

FEATURES

- Compact size
- Reliable design
- Multi pole



APPLICATIONS

- ON-OFF Switches
- Change over Switches
- Multi-step Switches
- Volt-Ammeter Switches
- Selector Switches
- Mains Switching
- Coolant Pumps

APPROVALS

- IEC EN 60947-3
- VDE 0660 part 107

BENEFITS

- Cost effective
- Easy to install
- High protection class

Panel mounted selector switches offer a 7-position voltmeter switch and a 4-position ammeter switch for reading line-to-line or line-to-neutral voltage and phase current.

Each switch is supplied with both numbered and colored annotation.

Description		Current Rating		
		6A	10A	16A
Ammeter Selector Switch 5 Position Line Current with OFF with Neutral		SWA-5P-6A ✓	SWA-5P-10A ✓	SWA-5P-16A ✓
Ammeter Selector Switch 4 Position Line Current with OFF		SWA-4P-6A ✓	SWA-4P-10A ✓	SWA-4P-16A ✓
Voltmeter Selector Switch 4 Position Voltage between Phases with OFF		SWV-4P-6A-LL ✓	SWV-4P-10A-LL ✓	SWV-4P-16A-LL ✓
Voltmeter Selector Switch 7 Position Voltage between Phases & Individual Phase to Neutral with OFF		SWV-7P-6A ✓	SWV-7P-10A ✓	SWV-7P-16A ✓
Voltmeter Selector Switch 4 Position Phase to Neutral Voltages with OFF		SWV-4P-6A-LN ✓	SWV-4P-10A-LN ✓	SWV-4P-16A-LN ✓

Rotary cam switches dimensional details

Type	A	B	C (max)	D	M1	M2	M3	R	S	W1	W2
Cam 6A	29	9.7	4	32	36	4	8	48	48	13	7
Cam 10A	29	9.5	4	43	36	4	7	60	48	19	5
Cam 16A	29	9.5	4	43	36	4	7	60	48	19	5

DIMENSIONS

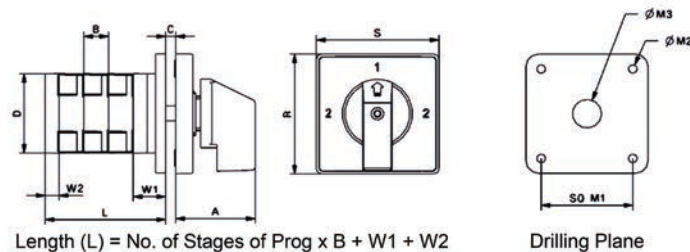

Product coding system

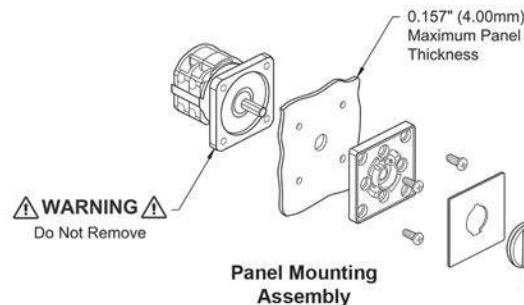

TE Connectivity Ltd. is a \$13 billion global technology and manufacturing leader creating a safer, sustainable, productive, and connected future. For more than 75 years, our connectivity and sensor solutions, proven in the harshest environments, have enabled advancements in transportation, industrial applications, medical technology, energy, data communications, and the home. With 78,000 employees, including more than 7,000 engineers, working alongside customers in nearly 150 countries, TE ensures that EVERY CONNECTION COUNTS. - www.TE.com.

Generation

- Conventional Power
- Nuclear Power
- Wind/Solar
- Hydro-electric

Transmission & Distribution

- Substation
- Underground
- Overhead
- Street Lighting

Industry

- Mining
- Petrochemical
- Railway
- Shipbuilding

WHEREVER ELECTRICITY FLOWS, YOU'LL FIND TE ENERGY



crompton-instruments.com

**FOR MORE INFORMATION:
TE Technical Support Centres**

- USA: +1 800 327 6996
- UK: +44 1376 509 401
- Australia: +61 1300 656 090
- Singapore: +65 6590 5151
- Hong Kong: +852 2790 9609

te.com/energy

© 2018 TE Connectivity Ltd. family of companies. All Rights Reserved. US - EPP-2042-US-03/19

TE Connectivity, the TE connectivity (logo) and Crompton Instruments are trademarks of the TE Connectivity Ltd. family of companies. Other logos, product and Company names mentioned herein may be trademarks of their respective owners. While TE has made every reasonable effort to ensure the accuracy of the information in this brochure, TE does not guarantee that it is error-free, nor does TE make any other representation, warranty or guarantee that the information is accurate, correct, reliable or current. TE reserves the right to make any adjustments to the information contained herein at any time without notice. TE expressly disclaims all implied warranties regarding the information contained herein, including, but not limited to, any implied warranties of merchantability or fitness for a particular purpose. The dimensions in this brochure are for reference purposes only and are subject to change without notice. Specifications are subject to change without notice. Consult TE for the latest dimensions and design specifications.

