

TD2 Series Time Delay Relay

Product Facts

- **Qualified to:**
 - MIL-PRF-83726/28
 - MIL-PRF-83726/29
 - MIL-PRF-83726/30
 - MIL-PRF-83726/31
- **Fixed delay on operate, fixed delay on release, adjustable delay on operate & adjustable delay on release**
- **Meets or exceeds electrostatic discharge MIL-STD-1686 Class Non-Sensitive**
- **Welded hermetically sealed enclosure occupies about 1 in³ (16.4 cm³)**
- **10A, 2 form C (DPDT) output contacts**

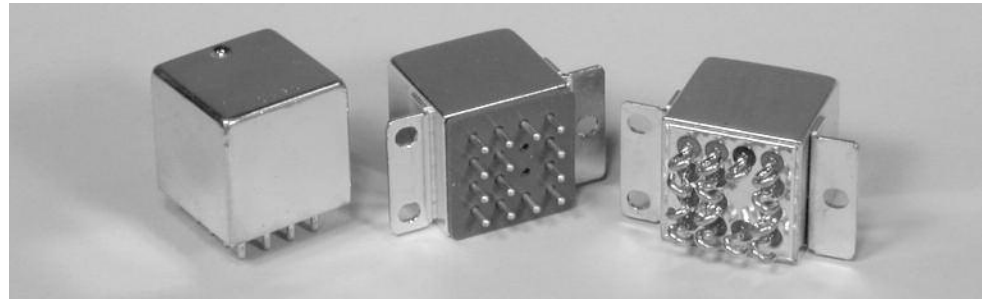

TD2 series time delay relays are available for delay on operate or delay on release operation. Either can be supplied as fixed or resistor adjustable types. Both military and commercial versions are offered.

These products consist of solid state timing circuits controlling our FCA-210 series relays, providing 2 Form C (DPDT) output contacts rated 10 amps. The internal timing circuit uses an R/C controlled oscillator with a program-

mable digital pulse counter, gating a semiconductor switch to operate the relay. Timing is independent of whether the controlling voltage is a ramp or step function.

For the adjustable models the user specifies a one decade range in seconds, within which the required delay will be set. This range is programmed internally at the time of manufacture. The required delay is obtained by calculating the oscillator timing resistor as

follows and connecting it externally to terminals 1D - 3D as below.

$$R_{EXT} = [(T_1 / T_0) - 1] 100K \text{ Ohms}$$

T_0 = Minimum time of selected decade in seconds.

T_1 = Required time delay.

EXAMPLE

Selected Range = 3-30 sec

Required Time = 15 sec

$$R_{EXT} = [(15/3) - 1] 100K = 400K$$

Timing Action and Terminal Wiring

Delay On Operate:

The time delay starts on the application of input voltage to X1-X2. The timing circuit energizes the end of the time delay period.

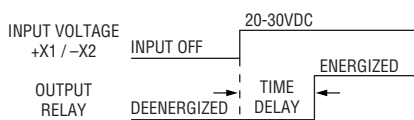

Fixed Model

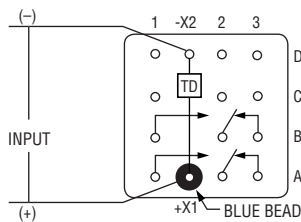

Adjustable Model

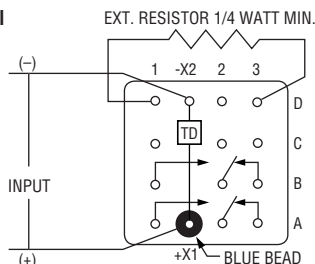

Delay On Release:

The input voltage is continuous to X1-X2. When the control voltage is applied to C1-X2 the timing circuit and the relay are both energized. The time delay starts when the control voltage is shut off.

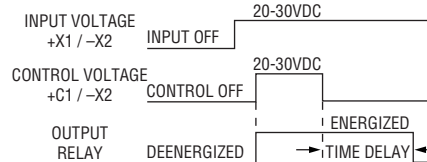

Fixed Model

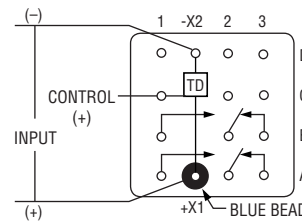

Adjustable Model

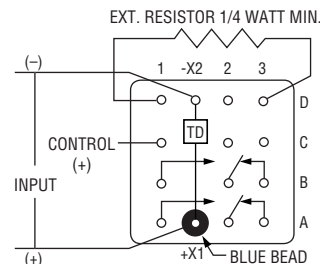

Terminal designations shown in the diagrams above are for reference only. They do not appear on the relay header.

TD2 Series Time Delay Relay (Continued)

Specifications

Timing Data

Timing Action	Delay on Operate or Delay on Release
Time Delay, Fixed – M83726/28, /29 and Commercial 28C, 29C	Select from 0.1 to 600 sec for Commercial Models Select from 0.1 to 500 sec for Mil-Spec Models
Time Delay, Adjustable – M83726/30, /31 and Commercial 30C, 31C	Select one decade between 0.1 to 1.0 and 60 to 600 seconds
Timing Accuracy (note 1)	±10% of Nominal Value
Recycle Time (note 2)	50 ms, max., to next cycle.
Power Interrupts	Accuracy is not affected by power interruptions up to 1 ms spaced at least 10ms apart.

Input Data

Input Voltage	28 Vdc nominal, range 20 - 32 Vdc
Duty Rating	Continuous
Input Current	110 mAdc Max @ 25°C
Control Voltage (applies only to Delay on Release type)	20 - 32 Vdc
Control Current	15 mAdc Max (applies only to delay on release types)
Input Voltage Polarity Protection	The timer will be inoperative during, and undamaged by, reversal of the polarity of the input voltage.

Output Data

Contact Form	2 Form C (DPDT)				
Contact Material	Silver Cadmium Oxide, Gold plated				
Contact Rating in Amps (Continuous Duty)					
	Type of Load	Life (Min.) Cycles	28 Vdc	115 Vac 400Hz	115/200 Vac – 3 phase 400 Hz. 60 Hz.*
	Resistive	100 x 10 ³	10	10	2.5
	Inductive	20 x 10 ³	8	8	2.5
	Motor	100 x 10 ³	4	4	2.0
	Lamp	100 x 10 ³	2	2	1.0

* 60 Hz. loads are rated at 10 x 10³ cycles.

Overload Current	40 Adc; 60A, 400 Hz.
Rupture Current	50 Adc; 80A, 400 Hz.
Max. Contact Drop at 10A	Initial 0.150V; After Life 0.175V

Electrical Data

Electrostatic Discharge Withstand Voltage	16,000V
Transients (note 3):	
Positive Transients	+80V
Self-generated Transients	±50V, Max.
Spike Susceptibility	±600V, 10 μs, Max.
Insulation Resistance (note 4)	1,000 megohms at 500Vdc, between each pin and case
Dielectric Strength (note 4)	1,000Vrms at 60 Hz at sea level, between case and all pins connected together

Environmental Data

Ambient Temperature Range, Operating	-55°C to +125°C
Altitude	80,000 feet maximum
Shock Resistance	100 G's, 6 ms.
Vibration Resistance, Sinusoidal	Z & Y Enclosure: 30 G's, 33-3000Hz.; X & W Enclosure: 20 G's, 33-3000Hz.

Mechanical Data

Approximate Weight	2.5 oz. (71g) Max.
--------------------	--------------------

NOTES

- The accuracy requirement applies to any combination of operating temperature and voltage. Add ±10ms for timing less than one second.
- Recycle time to assure that the next timing cycle will be completed. Units can be recycled during timing and after time-out:
Delay on operate models – Power must be OFF the input at least 10 ms. Delay on release models – Power must be ON the control terminal at least 10 ms.
- Transient specifications are based on a maximum duty cycle of 1/50.
- All wired terminals must be connected together during this test. Dielectric withstanding voltage and insulation resistance are measured between all mutually insulated wired terminals and between all these terminals and case.
- Inductive loads must be diode suppressed.

TD2 Series Time Delay Relay (Continued)

Outline Dimensions

The standard terminal types and enclosures are illustrated below with dimensions expressed as inches ± 0.010 and (millimeters ± 0.25).

Terminals

All terminals on 0.200 (5.4) centers.

CODE "P"

Socket Pins – Gold Plated

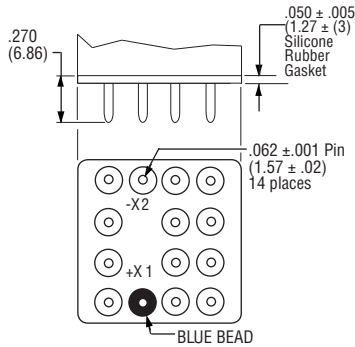

CODE "T"

Circuit Board Pins – Tin/Lead Plated

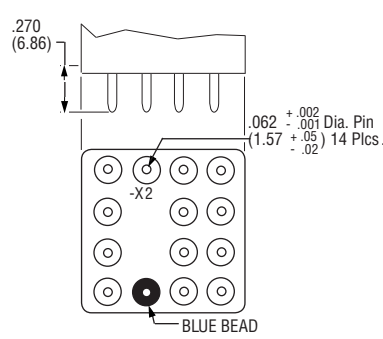

CODE "S"

Solder Hooks

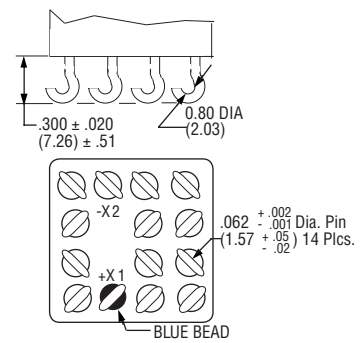

Enclosures

All Enclosures have cupro-nickel cans bright acid tin/lead plated after assembly to terminal headers.

CODE "Z"

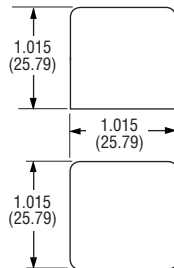

CODE "Y"

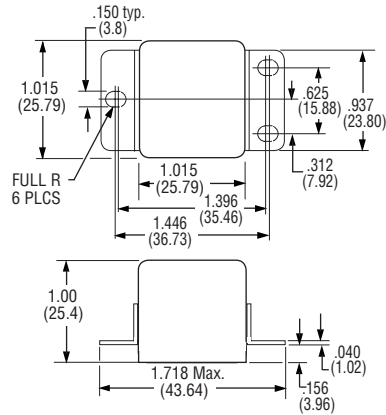

CODE "X"

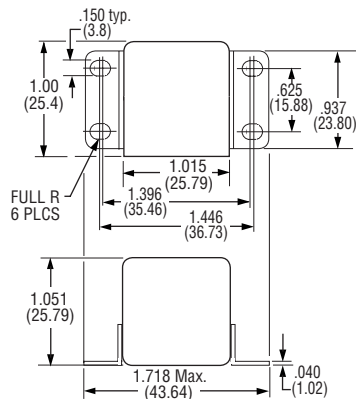

CODE "W"

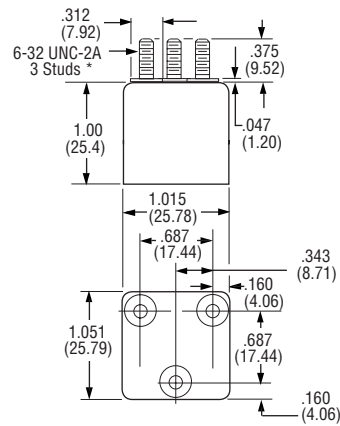

*Metric threads available. To specify use "M" in place of "W"

For factory-direct application assistance, phone 419-521-9500 or fax 419-526-2749.

TD2 Series Time Delay Relay (Continued)

**Part Numbering System
Mil-Spec Types**

Typical Mil-Spec Part Number	TD2	28-	5002	P
Series:				
TD2 = Time delay relay with 2 pole, 10A output				
Mil-Spec Model:				
28 = M83726/28 (Fixed, Delay on Operate)				
29 = M83726/29 (Fixed, Delay on Release)				
30 = M83726/30 (Adjustable, Delay on Operate)				
31 = M83726/31 (Adjustable, Delay on Release)				
Time Delay Range (Within 0.1 to 500 seconds):				
For /28 and /29 types (fixed types), the delay is expressed in milliseconds in a four-digit code. The first three digits are significant. The fourth is the number of zeros following the first three. Example: 5002 is 50 seconds.				
For /30 and /31 types (adjustable types), the delay decade range is expressed in milliseconds in a four-digit code representing the upper limit of the range. The first three digits are significant. The fourth is the number of zeros following the first three. Example: 1001 is 1 second, so the range is 0.1 to 1 second.				
Terminals:				
P= Socket Pin Terminals				
S= Solder Hook Terminals				

Note: Mil-spec models have "Y" type enclosure.

Commercial Types

Typical Commercial Part Number	TD2	28C-	1001	P	Y
Series:					
TD2 = Time delay relay with 2 pole, 10A output					
Commercial Model:					
28C = Fixed, Delay on Operate (COTS version of M83726/28)					
29C = Fixed, Delay on Release (COTS version of M83726/29)					
30C = Adjustable, Delay on Operate (COTS version of M83726/30)					
31C = Adjustable, Delay on Release (COTS version of M83726/31)					
Time Delay Range (Within 0.1 to 600 seconds):					
For fixed types, the delay is expressed in milliseconds in a four-digit code. The first three digits are significant. The fourth is the number of zeros following the first three. Example: 5002 is 50 seconds.					
For adjustable types, the delay decade range is expressed in milliseconds in a four-digit code representing the upper limit of the range. The first three digits are significant. The fourth is the number of zeros following the first three. Example: 1001 is 1 second, so the range is 0.1 to 1 second.					
Terminals:					
P= Socket Pin Terminals					
S= Solder Hook Terminals					
T= Solder Pin Terminals					
Enclosure					
W = Mounting Studs					
X = Horizontal Flange Mount					
Y = Raised Vertical Flange Mount					
Z = No Mount					

NOTE: Commercial versions are available with timing ranges outside of .1 to 600 sec. range.

For factory-direct application assistance, phone 419-521-9500 or fax 419-526-2749.